

Patient Instructions for Use of VYAFUSER™ Pump

VYAFUSER™ and PRODUODOPA™ are trademarks of AbbVie AB.

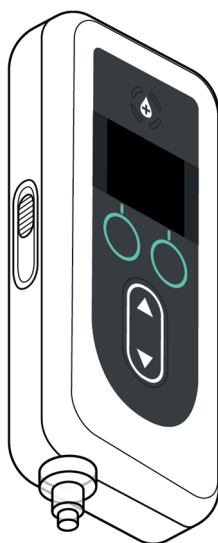

Phillips-Medisize A/S
Gimsinglundvej 20
DK-7600 Struer
Denmark

Registration Holder:
I.L EMERGO ISRAEL LTD, 9 Andrei
Sakharov St., Matam, P.O.B. 15054,
Haifa 3190501, Israel
Tel: 02-6731634

Registration number in the
National Medical Device
Registry: 24820287

These Instructions for Use are to be
used exclusively with the
PRODUODOPA™ Delivery System.



This Instruction for use is available on Phillips-Medisize website
<https://www.phillipsmedisize.com/ifu>

0000188

PRODUODOPA™ delivery system IFU is composed of HCP IFU and Patient IFU. Collectively, the patient IFU and HCP IFU form the complete PRODUODOPA™ delivery system IFU. Patient Instructions for Use is intended to be used by advanced Parkinson's patients, their Caregivers and HCPs. Patient IFU contains instructions on how to use the pump and accessories to deliver the drug.

Specific individual component IFUs (i.e., preparing solution IFU, carrying accessory IFU, vial adapter IFU, mains adapter IFU, battery charger IFU, and infusion set IFU) are referenced in the patient IFU.

These instructions are for use along with any other instructions your Healthcare Professional may give you. Follow only those steps where you have been trained by your Healthcare Professional. Please read the Preparing Solution Instructions for Use before you start using PRODUODOPA™ and each time you fill a new Syringe. HCP IFU is only intended for HCP to program the pump.

For questions or problems, call your Healthcare Professional, or call PRODUODOPA™ Support at 052-8113004.

TABLE OF CONTENTS

1. Introduction	1
1.1 Intended Use.....	1
1.2 Intended User	1
1.3 Indication for Use	1
1.4 Contraindications, Warnings, and Cautions	1
1.5 General	7
1.6 Delivery System Introduction	9
1.7 Delivery System Overview	10
1.8 VYAFUSER™ Pump Components.....	13
1.9 VYAFUSER™ Pump Display	15
1.10 Delivery Methods	18
2. Prepare PRODUODOPA™ and Infusion Set	19
2.1 Gather Supplies	19
2.2 Install Battery	21
2.3 Fill Syringe with PRODUODOPA™	24
2.4 Connect Infusion Set Tubing to Syringe	25
2.5 Place Filled Syringe in Pump	26
2.6 Prime Infusion Set Tubing.....	28
2.7 Insert Cannula into the Body	32
2.8 Connect Infusion Set Tubing to Cannula	34
3. Administer Therapy	35
3.1 Start Continuous Infusion Delivery	35
3.2 Stop and Resume Therapy	37
3.3 Change Rate	39
3.4 Administer Extra Dose.....	41
3.5 Stop/Cancel Extra Dose Delivery	43
3.6 Administer Loading Dose	44
3.7 Stop/Cancel Loading Dose	46
3.8 Resume Loading Dose.....	47
3.9 Choosing to Not Start Loading Dose	48
4. Disconnect from Pump (less than 1 hour) and Reconnect	49
4.1 Stop Therapy	49
4.2 Disconnect from Site Connector and Remove Drips	51
4.3 Resume Therapy (within 1 hour).....	52

5. Replace Syringe Only	55
5.1 Gather Supplies	56
5.2 Fill Syringe with PRODUODOPA™	58
5.3 Stop Therapy.....	59
5.4 Remove Used Syringe from Pump	60
5.5 Replace the Syringe.....	61
5.6 Place New Syringe in Pump.....	62
5.7 Resume Continuous Infusion Delivery.....	64
6. Replace Infusion Set Tubing and Cannula (not Syringe)	65
6.1 Gather Supplies	65
6.2 Stop Therapy.....	67
6.3 Remove Cannula and Disconnect Infusion Set Tubing from Syringe.....	68
6.4 Connect New Infusion Set Tubing	68
6.5 Prime Infusion Set Tubing	69
6.6 Insert Cannula into the Body	72
6.7 Connect Infusion Set Tubing to Cannula and Resume Continuous Infusion Delivery.....	74
7. Replace Syringe, Infusion Set Tubing, and Cannula	75
7.1 Gather Supplies	76
7.2 Fill Syringe with PRODUODOPA™	78
7.3 Stop Therapy.....	78
7.4 Remove Cannula from Infusion Site.....	79
7.5 Remove the Used Syringe from Pump	80
7.6 Connect New Infusion Set Tubing to New Syringe	82
7.7 Place New Syringe in Pump.....	83
7.8 Prime Infusion Set Tubing.....	84
7.9 Insert Cannula into the Body	88
7.10 Connect Infusion Set Tubing to Cannula and Resume Continuous Infusion	90
8. Troubleshooting	91
8.1 What do I do if my Syringe doesn't fit into the Pump?	91
8.2 What if I accidentally indicate Tubing is primed, but I need to continue to prime?	91
8.3 What do I do if I need to change only my infusion set tubing and not the Cannula?.....	92
8.4 What if I cannot loosen the Tubing from Syringe during Syringe replacement?.....	92

8.5 What if I am having trouble transferring PRODUODOPA™ from the Vial to the Syringe?	93
8.6 What if my fully-charged Battery lasts less than 24 hours?	93
8.7 What if I install a fully-charged Battery and the pump doesn't power on?	93
8.8 Instructions for cleaning Battery contacts (if needed).	94
8.9 What should I do if the Pump screen is blank or does not respond to any of my button pushes?	94
8.10 What should I do if my Cannula becomes detached from my body after I have been using it?	94
8.11 What if I cannot remove the site connector from the Cannula during temporary disconnect?	95
8.12 What should I do if the system is leaking or if the Tubing is blocked?	95
8.13 What should I do if my Pump gets wet?	96
8.14 What should I do if I spill PRODUODOPA™?	96
8.15 What if I need to stop using the Pump for an extended period of time?	96
9. Alarms and Informational Messages	97
9.1 Alarm Overview	97
9.2 High and Low Priority Alarms (listed alphabetically)	99
9.3 Informational Messages	104
10. Device Information	109
10.1 Last 3 Alarms	109
10.2 Software Version	110
11. Maintenance	111
11.1 Replace Battery	111
11.2 Cleaning the Pump, Mains Adapter and Charger	114
12. Technical Specifications	115
12.1 Battery Service Life	115
12.2 MRI Safety Information	115
12.3 Electromagnetic Compatibility	115
13. Reference	121
13.1 Explanation of Symbols	121
13.2 Pump Kit Labels	125
13.3 Tubing, Adapters, and Accessories	126
14. Storage and Transport Conditions	127

GLOSSARY

	Definition
Continuous Infusion Delivery	A delivery of PRODUODOPA™ that runs throughout the day and night. The Base rate is always available. A Low and/or High rate may also be delivered if enabled by your Healthcare Professional.
Extra Dose	A small, single-volume dose given over a short period of time (bolus) to achieve the desired therapeutic state quickly. The Extra Dose is only available if it is enabled by your Healthcare Professional.
Loading Dose	A large single dose given over a short period of time (bolus) that may be delivered at the initiation of therapy and/or after the Pump has not been delivering PRODUODOPA™ for an extended period of time (minimum of 3 hours).
Lockout Time	The duration of time during which an Extra Dose or Loading Dose cannot be delivered. These times are set by the Healthcare Professional.
Lockout Time: Extra Dose	If Extra Dose is enabled by the Healthcare Professional, the lockout time is the interval from the end of the delivery of the most recent Extra Dose or Loading Dose to the next Extra Dose becoming available.
Lockout Time: Loading Dose	If Loading Dose is enabled by the Healthcare Professional, the lockout time is the time during which the Pump has not been delivering PRODUODOPA™ before the Loading Dose becomes available (minimum of 3 hours). During this time, the Loading Dose option will not be visible on the Pump Display.
Solution	Liquid formulation in a glass medication vial that is prescribed by the Healthcare Professional.

1. Introduction

1.1 Intended Use

The PRODUODOPA™ Drug Delivery System is an automated drug delivery system intended for the infusion of PRODUODOPA™ to treat advanced Parkinson's disease.

The VYAFUSER™ Pump is an ambulatory infusion pump intended for the subcutaneous delivery of PRODUODOPA™.

1.2 Intended User

The PRODUODOPA™ Drug Delivery System is intended to be used by adult patients with advanced Parkinson's disease, caregivers, and healthcare professionals.

The VYAFUSER™ Pump is intended to be used by adult patients with advanced Parkinson's disease, caregivers, and healthcare professionals.

1.3 Indication for Use

PRODUODOPA™ is a combination of foscarnidopa and foslevodopa indicated for the treatment of motor fluctuations in patients with advanced Parkinson's disease.

The VYAFUSER™ Pump is an ambulatory infusion pump indicated for the treatment of motor fluctuations in patients with advanced Parkinson's disease.

The VYAFUSER™ Pump can be operated in both clinical and non-clinical environments, including the home, outside the home, and during travel (including air travel).

1.4 Contraindications, Warnings, and Cautions

Contraindications, Warnings, and Cautions notify you of potential hazards.

A CONTRAINDICATION is a condition under which a device should not be used because the risk of use clearly outweighs any possible benefit.

WARNING statements notify you of potential hazards that may result in serious injury or death. All warnings are written with [] symbol to the left of the warning.

CAUTION statements notify you of potential hazards that may result in moderate injury or damage to equipment.







It is expected that you should read and understand them prior to using this delivery system.

Contraindication

 The Delivery System should only be used with the PRODUODOPA™ which is prescribed to you by your Healthcare Professional.



Warnings



General

-  Only use VYAFUSER™ Pump in a manner described in these Instructions for Use, and as you were trained by your Healthcare Professional.
-  **Do NOT** interact with the Delivery System, including adjusting the dosage and/or addressing any alarms or informational messages, while operating motorized vehicles or machinery, or otherwise engaging in any activities where distractions need to be avoided.
-  Keep Battery and all other small parts of the Delivery System out of the reach of children. A small part may be a choking hazard for children.
-  **Do NOT** attempt to modify any part of the Delivery System because you could damage the system, harm yourself, or cause your therapy to be less effective.
-  **Do NOT** dilute the PRODUODOPA™ Solution or fill the Syringe with any substance other than what your Healthcare Professional prescribed.
-  Only use a qualified Carrying Accessory with the Delivery System. The Carrying Accessory provided with the Delivery System has been qualified for use.
-  **Do NOT** store the VYAFUSER™ Pump, Battery, or Battery Charging components outside of the recommended storage temperature range -4 °F to 140 °F (-20 °C to 60 °C).

Battery (RRC1120-PM)



To reduce the risk of damage to the Battery or Pump or to harm yourself:

-  **Do NOT** use a Battery that is different from the Model RRC1120-PM Battery provided by the VYAFUSER™ Pump supplier.
-  **Do NOT** open or dismantle batteries.

-  **Do NOT** expose batteries to direct source of heat.
-  **Do NOT** use batteries with any visible physical damage like cracks, broken parts etc.









Battery Charging Station Components (AC/Mains Adapter and Battery Charger)



To reduce the risk of electric shock or other harm to you:

-  **Do NOT** use the battery charging components if they appear damaged.
-  **Do NOT** use battery charging components that are different from the AC/Mains Adapter and Battery Charger provided by the VYAFUSER™ Pump supplier.

Disposable Components (Vial Adapter, Syringe, Infusion Set)





To minimize the risk of infection or allergic reactions:

-  **Do NOT** use any disposable components that have not been qualified for use with this system. This includes the Vial Adapter, Infusion Set, and Syringe. The list of qualified disposable components can be found at devices.abbvie.com.
-  **Do NOT** use any disposable components, including the Infusion Set and Vial Adapter, until you have read the Instructions for Use and have understood and will follow all warnings and cautions.
-  **Do NOT** use any disposable components past the expiration date on the label.
-  **Do NOT** use any disposable components if their sterile packaging has been damaged prior to use.
-  **Do NOT** re-use any disposable component, such as the Syringe or Vial Adapter.
-  **Do NOT** use an Infusion Set for a time period longer than that specified in the Instructions for Use or by your Healthcare Professional.
-  Always dispose of the used Infusion Set per local regulations.
-  **Do NOT** attempt to move the Cannula after it has been installed on the infusion site. If the Cannula needs to be re-adjusted, replace the infusion set (both Cannula and tubing) and change to a new infusion site.

-  To minimize the risk of infections when using disposable components (Vial Adapter, Syringe and Infusion Set), always adhere to the techniques specified by the Healthcare Professional. **Do NOT** let the tip of any disposable component come into contact with any unclean surfaces. If the tip of any disposable component comes into contact with an unclean surface, discard it and get a new one.
-  Once you have opened disposable component packaging, it should be used or discarded and not saved for later use.
-  **Do NOT** touch your infusion site area once it has been cleaned.

System Use Conditions

To reduce the risk of Pump malfunction and harm to yourself:

-  **Do NOT** use or wear the Delivery System while engaging in any activity that could result in liquids getting onto or into the Pump, such as bathing, showering or swimming.
-  **Do NOT** use the Pump if it has been submerged in water or any other liquid. Contact the Healthcare Professional for assistance in getting the Pump replaced.
-  Portable RF communications equipment (e.g., cell phones, laptops, tablets, Wi-Fi routers, cordless phones, including peripherals such as antenna cables and external antennas) should be used no closer than 3.1 inches (8 cm) to any part of the pump. Otherwise, degradation of the performance of this equipment could result.
-  Always keep the Delivery System away from unintended conditions/ environments. Examples include:
 - any direct source of heat (e.g., radiator, stove, sauna)
 - high moisture (greater than 90% relative humidity) (e.g., steam room)
 - contact with or directly next to other electrical equipment (e.g., do not keep the VYAFUSER™ Pump on or directly next to other electrical equipment such as a laptop or clock radio, or place other electrical equipment on the VYAFUSER™ Pump).
 - strong electromagnetic fields (e.g., magnets, MRI devices, loudspeakers)
 - high levels of ionizing radiation (e.g., medical X-ray)
 - ultrasound devices
 - oxygen-rich environments (e.g., surgical rooms)

- environments containing flammable anesthetics (e.g., a room where anesthetic gas is used)
- hyperbaric chambers (e.g., pressure chamber where the working pressure is higher than sea level atmospheric pressure)



Your Pump contains magnets, which might interfere (for example, alter device function, turn device on/off) with the operation of other electronic medical devices (for example, Deep Brain Stimulator, pacemaker, cardio-defibrillator, hearing aid) in use.

If you have an implanted cardiac device, such as a pacemaker and/or cardioverter-defibrillator, keep the VYAFUSER™ Pump positioned at least 150 mm (6 inches) from the cardiac device.

Consult the instructions for these devices and consult your physician for additional information prior to using the Pump.

Note: Your Pump has a magnetic flux density of less than 10 gauss at a distance of 1 inch (25 mm) from any surface when in use.

Cautions

General

If the following cautions are not followed, then the system may not function as intended:

- Use the Delivery System only for subcutaneous (under the skin) delivery.
- **Do NOT** operate the Delivery System outside the recommended operating temperature range of 41 °F to 104 °F (5 °C to 40 °C), inclusive.
- **Do NOT** heat any component of the Delivery System in any type of oven, including a microwave oven.
- If the Pump is dropped, inspect it for damage. If any damage is detected, don't use it and call your Healthcare Professional immediately.
- When the VYAFUSER™ Pump displays an alarm or informational message you must perform the corrective actions as described in the Instructions for Use, if applicable.
- **Do NOT** use the Infusion Set Tubing, Carrying Accessory straps or belt, or battery charging station cable in a way that could wrap around your neck.
- **Do NOT** place your fingers or hand in a position that could result in it getting pinched, such as when closing the Pump Lid or Battery Cover.

- If you think the skin around your infusion site is irritated, call your Healthcare Professional.

Preparing PRODUODOPA™ for Use

If the following cautions are not followed, then the therapy may not be effective or safe.

- **Do NOT** store the unopened Solution Vials outside the recommended storage conditions specified in the **Preparing Solution Instructions for Use**, included with the Solution Vial carton.
- **Do NOT** use an unopened Solution Vial if it has been out of the recommended refrigerated temperature range for longer than the number of days specified in the **Preparing Solution Instructions for Use**, included with the Solution Vial carton.
- **Do NOT** use the PRODUODOPA™ Solution if it has been in the Syringe for more than 24 hours.
- **Do NOT** use the PRODUODOPA™ Solution if it is cloudy or contains flakes or particles.
- **Do NOT** freeze the PRODUODOPA™ Solution.
- **Do NOT** infuse hot fluids.
- If refrigerated, **do NOT** warm PRODUODOPA™ (in Solution Vial or Syringe) in any way other than letting it warm at room temperature. For example, do NOT warm in microwave or in hot water.
- Always withdraw the entire contents of the Solution Vial into the Syringe. **Do NOT** save PRODUODOPA™ Solution in Solution Vial for later use.

Disposable Components (Vial Adapter, Syringe, Infusion Set)

- Inspect all disposable components before use and **do NOT** use any of them if they are damaged. Use of damaged components may not be safe.
- Always insert the Cannula as indicated in the Infusion Set Instructions for Use and care for your infusion site as directed by your Healthcare Professional or you could risk infection of the infusion site.
- **Do NOT** prime the Infusion Set tubing when connected to the body. Priming the tubing while connected to the body may result in unintended drug delivery.
- Always visually inspect the infusion site for bleeding immediately after inserting the Cannula. If you see blood in the tubing and/or near

the infusion site, replace the infusion set (both Cannula and tubing) and choose a new infusion site.

- Always visually confirm that the Cannula is completely removed from your body when you remove the Cannula adhesive. If you think the plastic part of the Cannula was detached from the adhesive and is still under your skin, call your Healthcare Professional.

Battery

If the following cautions are not followed, it may lead to battery fluid leaks and may not be safe.

- Always remove the Battery if the Pump will not be used for a period of 1 month or longer.
- Recycle/dispose of batteries according to national and local regulations.
- In the event of a battery leaking, **do NOT** allow the liquid to come in contact with the skin or eyes. If battery liquid contact has been made, wash the affected area with plenty of water and call your Healthcare Professional.

1.5 General

- The PRODUODOPA™ should not be used for more than 24 hours after it has been put into the Syringe. After 24 hours, the Syringe should be discarded with any unused PRODUODOPA™ and be replaced by a new Syringe of fresh PRODUODOPA™.
- When the Syringe is in the pump and the infusion set tubing is connected to the body, no portion of the Syringe can be higher than 7 3/4 inches (20 cm) above the infusion site or lower than 21 1/2 inches (55 cm) below the infusion site. Placing it higher or lower than indicated could impact delivery accuracy.
- **OPERATING CONDITIONS:** The Pump, Battery Charging System, and Carrying Accessory are designed to operate as intended when operating with in a temperature range of 41 °F to 104 °F (5 °C to 40 °C), inclusive, within the humidity range of 15% to 90% non-condensing, inclusive, and within the atmospheric pressure range of 70 kPa to 106 kPa, inclusive.
- The Pump is designed to operate in the electromagnetic environment specified in the section **Technical Specifications: Electromagnetic Compatibility**.

Clinical Benefit

The PRODUODOPA™ Delivery System enables the continuous delivery of the PRODUODOPA™ medicinal product which results in stable and predictable control of motor fluctuations in patients with advanced Parkinson's disease through a minimally invasive, nonsurgical approach.

Residual Risk Communication

Always use the PRODUODOPA™ Delivery System as directed by the Instructions for Use. When using this therapy, you may experience the following:

- Infusion site events such as redness, swelling, pain, cellulitis and abscess at the infusion site
- Return of symptoms of your Parkinson's disease like shaking, feeling stiff, slow movement, problems keeping your balance if you get too little medication
- Movements that you cannot stop, high or low blood pressure, nausea, vomiting or hallucinations if you get too much medication

Additional information about residual risks is covered in the Warning and Cautions section.

Expected Service Life

- The expected service life of the Pump is 3 years.

1.6 Delivery System Introduction

These Instructions for Use provide information for the VYAFUSER™ Pump (see *Figure A*). These instructions are for use along with any other instructions your Healthcare Professional may give you. Follow only those steps where you have been trained by your Healthcare Professional. Please read the **Preparing Solution Instructions for Use** before using PRODUODOPA™ and filling a new Syringe.

The VYAFUSER™ Pump is an ambulatory infusion pump that uses single-use syringes for the controlled subcutaneous administration of PRODUODOPA™. It provides continuous infusion 24 hours a day, 7 days a week. The continuous infusion does not always sound like it is infusing because it delivers drug product for about 2 seconds and then rests

for an interval in order to achieve the set flow rate. The Pump can be operated in both clinical and non-clinical environments, including the home, outside the home, and during travel (including air travel).

When delivering PRODUODOPA™, the Pump can be positioned in any orientation (horizontally or vertically).

Your Healthcare Professional prescribed PRODUODOPA™ for you and programmed the VYAFUSER™ Pump. For questions or problems, please contact your Healthcare Professional.

The VYAFUSER™ Pump is used for the delivery of PRODUODOPA™ through subcutaneous infusion.

Note: Do NOT attempt to disassemble the Pump.

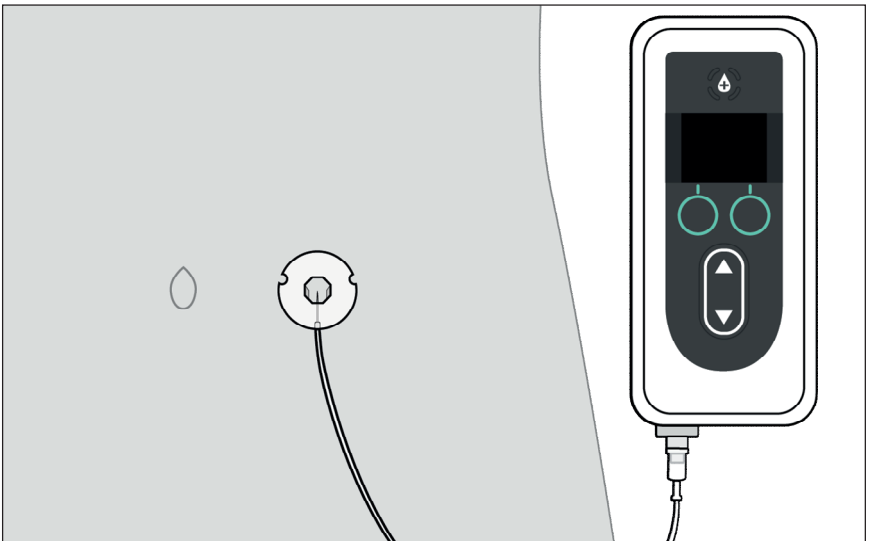





Figure A





1.7 Delivery System Overview



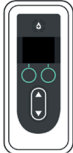

The System refers to the Pump, the Solution Vial, and all of the items shown in the following table.

Note: When you get your new Pump, the Battery may not be fully charged. Charge your spare Battery immediately. When it is fully charged, replace the Pump Battery with the newly charged Battery and begin to charge the one you replaced (see section **Maintenance: Replace Battery**).

Note: The Cannula and Infusion Set Tubing must be changed at regular intervals, as per the instructions from your Healthcare Professional.

Item	Purpose	Instructions for Use
Solution Vial 	The Solution Vial contains the PRODUODOPA™.	Vial Adapter Preparing Solution
Vial Adapter 	The Vial Adapter is attached to the Solution Vial and is used to transfer the PRODUODOPA™ from the Solution Vial to the Syringe. Your Vial Adapter may look different from the one illustrated here.	Vial Adapter Preparing Solution
Syringe 	The Syringe is to be filled with PRODUODOPA™ and is then used in the Pump to deliver PRODUODOPA™.	Preparing Solution Patient Instructions for Use of VYAFUSER™ Pump Infusion Set

Item	Purpose	Instructions for Use
<p>Pump</p> 	<p>The infusion Pump delivers PRODUODOPA™ from the Syringe through the Infusion Set Tubing and into the infusion site.</p> <p>VYAFUSER™ Pump: Model number and Serial number are found when the Pump lid is open.</p>	<p>Patient Instructions for Use of VYAFUSER™ Pump</p> <p>VYAFUSER™ Pump Carrying Accessory</p>
<p>Infusion Set Tubing (Infusion Line)</p> 	<p>The Infusion Set Tubing connects the Syringe in the Pump to the infusion site to deliver the PRODUODOPA™.</p> <p>Your Infusion Set Tubing may look different from the one illustrated here. It may also be called an Infusion Line.</p>	<p>Patient Instructions for Use of VYAFUSER™ Pump</p> <p>Preparing Solution</p> <p>Infusion Set</p>
<p>Insertion Device and Cannula</p>  <p>Insertion Device</p>  <p>Cannula</p>	<p>The Insertion Device is used to insert the Cannula into the body. It may do this through a mechanical method or manual method, depending on your Insertion Device.</p> <p>When the Cannula is inserted into the infusion site, it allows the PRODUODOPA™ to flow into your body.</p> <p>Your Insertion Device and Cannula may look different from the ones illustrated here.</p>	<p>Preparing Solution</p> <p>Infusion Set</p>

Item	Purpose	Instructions for Use
<p>Battery</p> 	<p>The rechargeable Battery is used as the power source for operating the Pump. It must be the Model RRC1120-PM Battery.</p>	
<p>AC/Mains Adapter</p> 	<p>The Battery Charger and AC/Mains Adapter (with charging cable) are used to charge one Battery while the other is in use. This will ensure the Pump will always have sufficient power to operate.</p>	<p>AC/Mains Adapter (Instruction Manual Power Supplies)</p>
<p>Battery Charger</p> 	<p><i>Note:</i> The AC/Mains Adapter IFU contains safety information and should be read to become familiar with the warnings about the adapter and how the adapter is used. The IFU also illustrates an adapter that requires assembly. Your AC/Mains Adapter is pre-assembled. If it becomes disassembled, refer to the AC/Mains Adapter IFU as needed.</p>	<p>Battery Charger (RRC SCC1120-PM Series)</p>
<p>Carrying Accessory</p> 	<p>The Carrying Accessory is used to carry the Pump on your body when you are mobile.</p> <p>The Carrying Accessory contains a Carrying Case, Belt, Strap and removable front flap.</p>	<p>VYAFUSER™ Pump Carrying Accessory</p>

1.8 VYAFUSER™ Pump Components

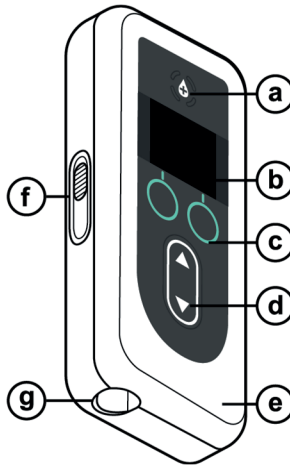

a.	Extra Dose Button	Used to deliver Extra Doses of PRODUODOPA™, if allowed, as determined by the Healthcare Professional.
b.	Display	Contains Pump status information and options for user actions.
c.	Selection Buttons	Used to select between different choices on the Display.
d.	Arrow Keys	Up Arrow: Used to scroll through menu options or increase a value. Down Arrow: Used to scroll through menu options or decrease a value.
e.	Lid	The Pump is a clamshell which opens for inserting and removing the Syringe. This part of the clamshell, with the Display, Buttons, and Arrow Keys, is referred to as the Lid.
f.	Lid Latch	The Lid Latch can be slid to release the Lid closing lock.
g.	Syringe Opening	The portion of the Syringe that connects to the tubing protrudes through this opening.

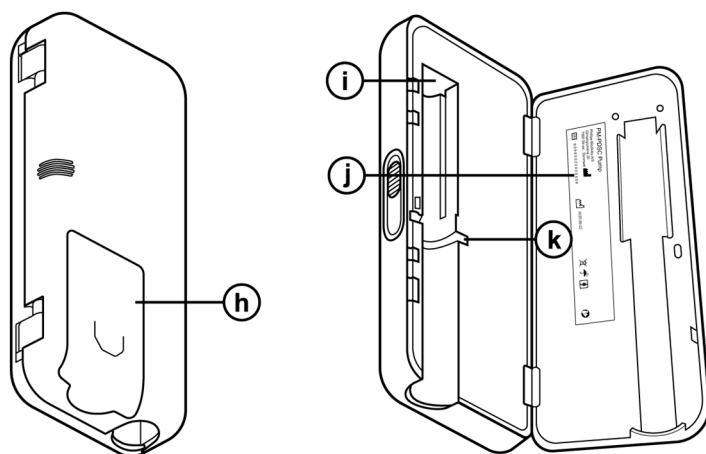

h.	Battery Cover	Slides into place to close the Battery compartment
i.	Syringe Plunger Rod Pusher	Pump mechanism that pushes against the Syringe plunger rod to control the flow of PRODUODOPA™.
j.	Pump Information	Includes model and serial number.
k.	Syringe Flange Grooves	Houses the Syringe flanges and ensures proper alignment of the Syringe when inserted into the Pump.

If you need assistance in setting up the system, using, or maintaining the system, or are missing any components, contact your Healthcare Professional.

If you notice any changes in performance of the Delivery System or unexpected events that are not described in the Troubleshooting section, contact your Healthcare Professional. If you need to replace your pump and/or dispose of it, contact your Healthcare Professional.





Note: If the pump is to be recycled/disposed, do so according to local regulations.

1.9 VYAFUSER™ Pump Display

Note: If needed, insert a Battery into the Pump (see section **Maintenance: Replace Battery**).

Battery Charge

The battery icon indicates different charge levels in a progression from 4 white bars down through 3, 2, and 1 white bar, then to 1 yellow bar and finally to a yellow outline with no bars.

Battery Icon	Meaning
	Four white bars: fully charged
	One white bar: ensure replacement battery is available
	Yellow outline and one yellow bar: battery could be depleted within 4 hours
	Yellow outline and no bars: battery could be depleted within 30 minutes. Replace immediately.

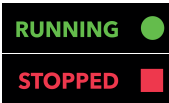

Pump Status

Used to show Pump status.

Note: For other screens that are not the Status Screen, the top right corner will display only a green circle (for Pump running) or red square (for Pump stopped).

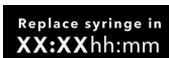

Replace syringe in

Represents the hours and minutes remaining until the Syringe will be empty, or how many hours and minutes remain until the PRODUODOPA™ remaining in the Syringe should be discarded and replaced with a new Syringe.

Note: The number representing hours and minutes may change when the rate is changed.



Current Rate

Displays the Rate that is being pumped in milliliters per hour (mL/h).

SCREEN OFF**Display On/Off**

Pressing the left Selection Button turns the Pump Display off. Turning off the Pump Display helps to save Battery power.

Note: This will not turn the Pump on or off, it will only turn off the Display.

Note: If SCREEN OFF is not pressed, the Pump Display will turn off after 20 seconds of inactivity.

To turn the screen on, press either Arrow Key or Selection Button.

**High priority alarm with audible tones (red)**

Pump has stopped. Take action to resolve.

**Low priority alarm with audible tones (yellow)**

Pump is running. If action is not taken as indicated in the alarm message, it may lead to high priority alarm.

**Alarm acknowledged but not resolved**

Audible tones are silenced by pressing any button.

**Informational message with audible tones**

Provides status information.

**Extra Dose**

Indicates the physical Extra Dose button.

**Up**

Indicates when there are additional menu options above the top displayed item.

**Down**

Indicates when there are additional menu options below the bottom displayed item.



Status Screen

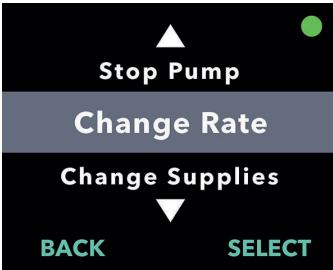

Pump Menu

Pump Menu

Pressing the MENU Button will display the Pump Menu options.

When menu options are displayed, the SELECT button will choose the highlighted menu option. The Pump Menu are used to make changes in therapy and supplies.

MENU

Pressing the right MENU button will display additional menu options.

BACK

Back

Navigates back to the Status Screen.

SELECT

Select

Selects the highlighted Menu selection option. The highlighted option is changed by pressing the arrow keys.

1.10 Delivery Methods

The Pump Delivers PRODUODOPA™ in 3 ways:

	Purpose	When it is available	How to access it
Continuous Infusion	Main mode that delivers a continuous dose of PRO-DUODOPA™ throughout the day.	Always available, as prescribed.	Select MENU and then the option to “Start Pump” and follow the prompts (see section Start Continuous Infusion Delivery).
Extra Dose	A small, single-volume dose given over a short period of time (bolus) to achieve the desired therapeutic state quickly. The Extra Dose is only available if it is enabled by your Healthcare Professional.	Available as needed, defined by a pre-set Extra Dose lockout time.	While the Pump is running, press the Extra Dose button two times (see section Administer Extra Dose).
Loading Dose	A large single dose given over a short period of time (bolus) that may be delivered to achieve the desired therapeutic state quickly, only available after the Pump has been off for an extended period and it is enabled by your Healthcare Professional.	After therapy has not been delivered for an extended period of time, defined by the Loading Dose lockout time (minimum of 3 hours).	Select MENU and then the option to Start Loading Dose (see section Administer Loading Dose) <i>Note:</i> The Loading Dose option is only available when the Pump has been off for an extended time. It is only accessible after “Start Pump” is selected and is not selectable from the main display MENU option.

2. Prepare PRODUODOPA™ and Infusion Set



Please refer to the **Preparing Solution Instructions for Use** and the **Infusion Set Instructions for Use**.

Preparing Solution and Infusion Set

2.1 Gather Supplies

1. Select a clean, flat well-lit workspace.

Note: To minimize the risk of infection, ensure your work surface is clean.

2. As needed, open the Pump kit and remove all items.

3. Gather supplies, including (see *Figure B*):

- Pump
- Syringe
- New, Unused Paper Towels
- Insertion Device*
- Solution Vial
- Vial Adapter*
- Alcohol Pads
- Infusion Set*

Note: Always ensure that you have replacements for all of your disposable components.

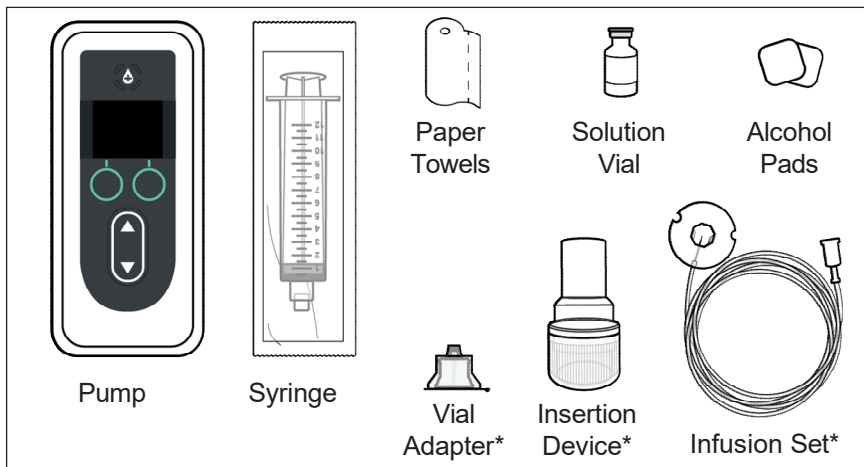

Figure B

*Your Insertion Device, Infusion Set, and Vial Adapter may look different from the ones illustrated in *Figure B*.

Note: If refrigerated, ensure the Solution Vial has been warming at room temperature for 30 minutes before filling the Syringe.

4. Inspect components for expiration and for any packaging damage.

- a. Inspect and verify that all components have not expired and that there is no damage to any of the packaging. If any of the components have expired or if the packaging is damaged, **do NOT** use, and contact your Healthcare Professional.
- b. Inspect the contents of the Solution Vial and verify that you **do not** see cloudiness or particles in the liquid.

Note: The product packaging for the Infusion Set, Vial Adapter and Syringe indicate that they are sterile and how they were sterilized.

Warning: Verify that the solution is the PRODUODOPA™ prescribed by your Healthcare Professional.

Warning: Check expiration date for all disposable components. **Do NOT** use component if it is expired.

Warning: **Do NOT** use any disposable components if their sterile packaging has been damaged prior to use.

Caution: Inspect all disposable components before use and **do NOT** use any of them if they are damaged.

Caution: **Do NOT** use the PRODUODOPA™ if it has been in the Syringe for more than 24 hours.

Caution: **Do NOT** use the PRODUODOPA™ if it is cloudy or contains flakes or particles.



Figure C

5. Wash your hands with soap and water and dry them (see Figure C).

2.2 Install Battery

Note: Always charge the used Battery immediately after removing it from the Pump. This will ensure that you have a fully charged spare Battery available at all times. Only use a fully charged Battery, Model RRC1120-PM.



Please refer to your **AC/Mains Adapter Instructions For Use and Battery Charger Instructions For Use** in this section.

AC/Mains Adapter Battery Charger

- 1. Remove the Pump and one Battery from the package.**
 - a. Inspect the Pump and Battery to ensure there is no damage.
- 2. Set up Charging System.**
 - a. Remove AC/Mains Adapter, charging station cable, and Battery Charger from Pump kit.
 - b. Connect the charging station cable to both the AC/Mains Adapter and Battery Charger.
 - c. Plug AC/Mains Adapter into wall outlet.
 - d. Ensure red indicator is lit.
 - e. When red indicator is lit, the Battery Charger is ready to charge the Battery.
- 3. Insert the uncharged Battery into the Battery Charger to begin the charging process.**

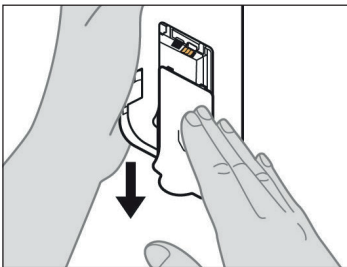

Figure D

- 4. Remove the Battery Cover from the Pump (see Figure D).**

Note: Always charge batteries fully before storing. Failure to do so could affect the operation of the Battery and the charger.

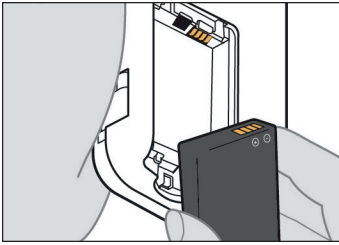

Figure E

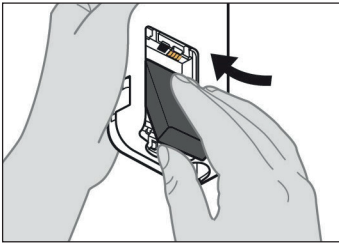

Figure F

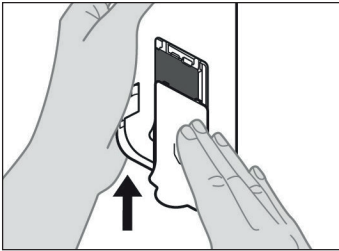

Figure G

5. Insert Battery into the Battery compartment.

Note: Use only a fully charged Battery, Model RRC1120-PM, provided by the VYAFUSER™ Pump supplier.

- a. Match the metal contacts of the Battery and Battery compartment (see *Figure E*).
- b. With the metal contact end inserted first, slide the Battery into the compartment (see *Figure F*).

Note: You will hear a “click” when the Battery is in place.

6. Slide the Battery Cover onto the Pump (see *Figure G*).

- a. Once the Battery is installed, the Display will turn on.

Note: Always ensure the Battery Cover is fully closed prior to use.

7. Insert the used Battery into the Battery Charger to begin the charging process.

Preparing for use.
Please wait...

8. After inserting the new Battery, the Pump will run power on self tests.

Please wait.

9. After inserting the Battery, wash your hands with soap and water and dry them.



STOPPED

Replace syringe in
XX:XX hh:mm

Rate
Base X.XX mL/h

SCREEN OFF

MENU

10. When the self tests are completed, the Pump will display the Status screen.

2.3 Fill Syringe with PRODUODOPA™

1. Select a clean, flat well-lit workspace.

Note: To minimize the risk of infection, ensure your work surface is clean.

Warning: To minimize the risk of infections, **do NOT** let the tip of any disposable component come into contact with any unclean surfaces. If the tip of the Vial Adapter or Syringe comes into contact with an unclean surface, discard it and get a new one.



Preparing Solution

2. Fill Syringe with PRODUODOPA™.

Please refer to your **Preparing Solution Instructions For Use** for detailed steps on how to:

- Connect the Vial Adapter to the Solution Vial
- Transfer the PRODUODOPA™ from the Solution Vial to the Syringe
- Remove air bubbles
- Purge all air from the Syringe

2.4 Connect Infusion Set Tubing to Syringe



1. Remove Infusion Set Tubing from the package.

Please refer to your ***Infusion Set Instructions For Use*** for detailed steps.

Infusion Set

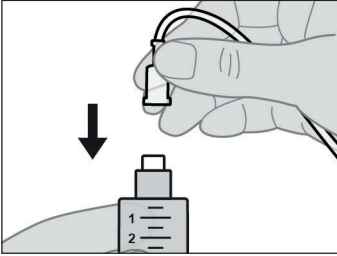

Figure H

2. Attach the Infusion Set Tubing to the new Syringe (see Figure H).

Note: The Cannula and Infusion Set Tubing must be changed at regular intervals, as per the instructions from your Healthcare Professional.



Warning: To minimize the risk of infections, **do NOT** let the tip of any disposable component come into contact with any unclean surfaces. If a tip of the Infusion Set Tubing or Syringe comes into contact with an unclean surface, discard it and get a new one.

2.5 Place Filled Syringe in Pump

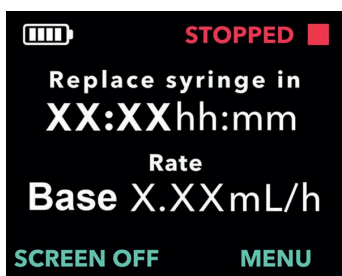

1. Turn on the Pump Display.

- Press any button (Arrow Keys or Selection Buttons).
- Press MENU to display the Pump Menu options.

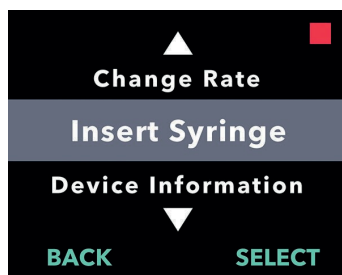

2. Use the Arrow Keys to highlight the *Insert Syringe* menu option.

- Press SELECT to choose the option to *Insert Syringe* and then follow the instructions on the Display.

Note: The Pump Display will have an *Insert Syringe* menu option when the Pump does not detect that a Syringe has been inserted.

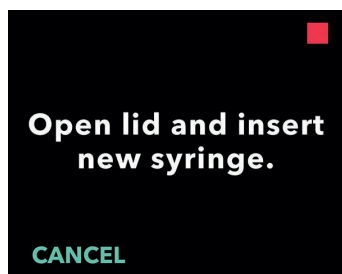

3. Slide the Lid Latch to release the lock and open the Pump Lid (see *Figure I*).

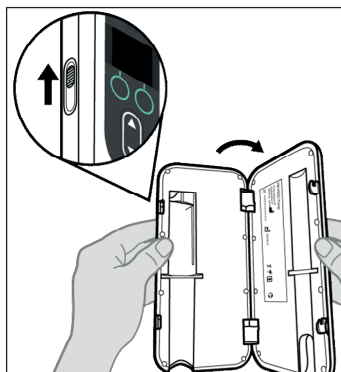

Figure I

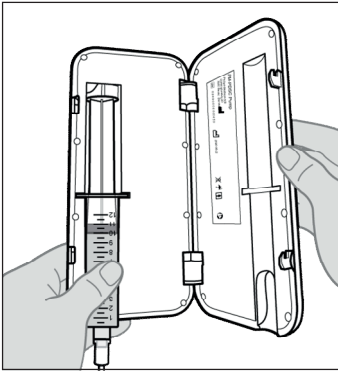

Figure J

**Insert new syringe.
Close lid.**

**Is new syringe
inserted?**

NO

YES

**Preparing for use.
Please wait...**



4. Place the Syringe into the Pump.

- a. Place the Syringe into the Pump groove with the Syringe flanges in the Syringe Flange Grooves (see Figure J).

Note: The Syringe should fit into the Pump groove with little to no resistance. If the Syringe does not fit inside the Pump groove, check to see if the Syringe plunger has been advanced to the correct position and air has been removed.

Note: Ensure the Syringe is correctly seated in the Pump before closing the Pump Lid.

If the Syringe does not fit into the Pump because there is still air in the Syringe tip, make sure the tubing is not connected to the Cannula, and then carefully push out the remaining air, being careful not to also push out any of the PRODUODOPA™.

- b. Close the Pump Lid until it snaps shut and the Syringe is secured in place.
- #### 5. Confirm the new Syringe has been inserted.
- a. Press YES.
 - b. Pause to allow the Pump to prepare the new Syringe for use.

2.6 Prime Infusion Set Tubing

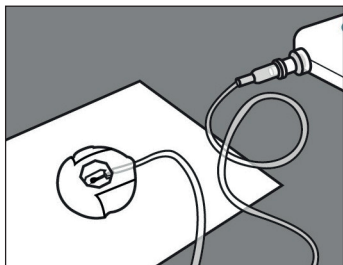
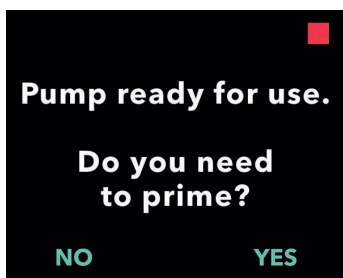

Figure K

1. Prepare to prime the Infusion Set.

- a. Lay the needle end of the Infusion Set on a clean Paper Towel so that the drops will fall on the Paper Towel and will not fall onto any part of the connector (see *Figure K*).

Note: Your Infusion Set may look different from the one illustrated here.



2. Start the priming process.

- a. Press YES.

Note: Ensure that the site connector remains on the clean paper towel while priming.

Note: If the Tubing is new, you need to prime it.

Note: Pressing NO will return you to the "Start Pump" Screen.

Note: If you need to prime and you are not seeing this screen, from the status screen select "MENU", scroll to and select "Change Supplies", and then scroll to and select "Prime Infusion Line."

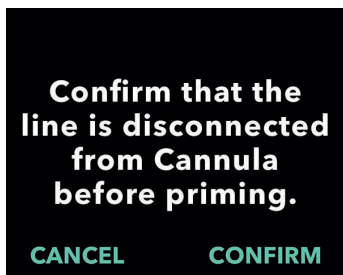

3. Confirm the Infusion Line is NOT connected to the Cannula.

- a. Press CONFIRM.

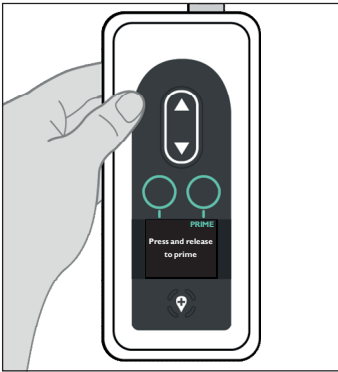

Figure L

**Hold pump
with syringe tip
straight up**



**Press and release
to prime**

PRIME

4. Prime the Infusion Set.

- a. Hold the Pump with the Syringe tip straight up (see *Figure L*).

Note: The Display will rotate so that you can read it when the Pump is held this way for priming.

- b. Press PRIME.

Note: The Pump must be pointing straight up and not tilted or the option PRIME will not appear. Make sure the Pump is not tilted.

Note: If the Pump is tilted slightly, the display will indicate the Syringe tip must point straight up in order to be able to prime.

Note: Each time you press PRIME, the Pump will deliver a volume of Solution into the infusion set and stop. (Continue on next page.)

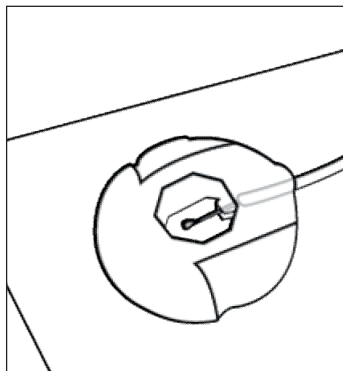

Figure M

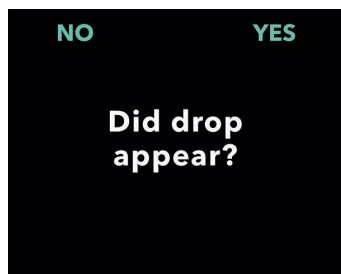
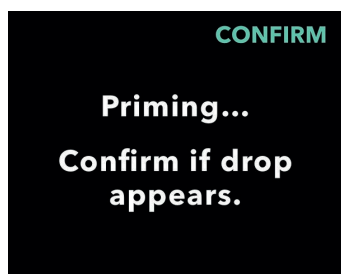

Figure N

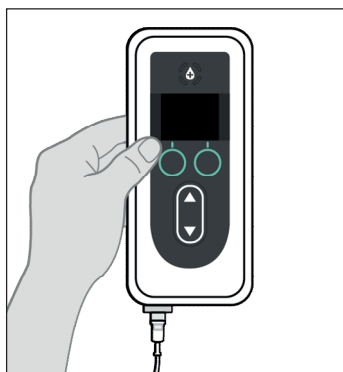

Figure O

5. Look for a drop of **PRODUODOPA™** on the site connector needle (see *Figure M*).

- a. Press CONFIRM when you see a drop of PRODUODOPA™ on the site connector needle.
- b. Press YES to confirm the appearance of the drop.

Note: It may take several seconds for the drop to appear.

Note: If CONFIRM is not pressed, you will be asked if a drop appeared (see *Figure N*).

Note: Pressing NO will return you to the "Press and release to prime" screen, allowing you to continue priming until a drop appears.

6. Return the Pump to its original orientation (see *Figure O*) and place flat on the table.

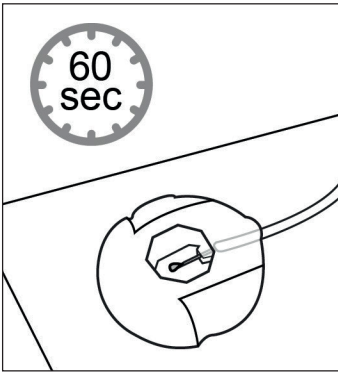

Figure P

7. Wait at least **60 seconds** to ensure that the **PRODUODOPA™** has stopped dripping from the needle (see *Figure P*).

Note: You **MUST** wait at least 60 seconds for the dripping to stop.

Note: Ensure that the site connector remains on the clean paper towel while priming.

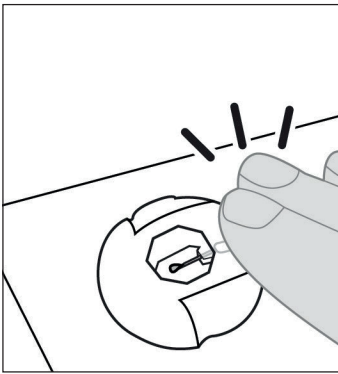

Figure Q

8. Without lifting the connector from the paper towel, tap the site connector with your finger so that any drops break free from the needle tip (see *Figure Q*).

Note: Before attaching the connector to the Cannula, make sure it is free of drops or it may later be difficult to detach from the Cannula.

Note: Some infusion sets come with protective caps, allowing you to recap the site connector and recap the Cannula until it is time to connect them.

2.7 Insert Cannula into the Body

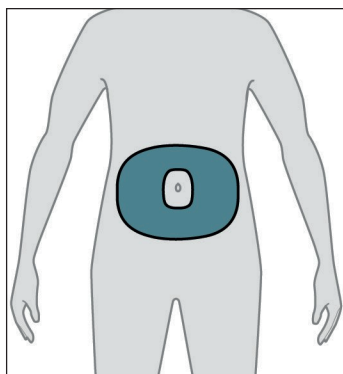

Figure R

1. Select your desired infusion site.

Note: The following instructions describe how to insert the Cannula into your abdomen. In some cases, your Healthcare Professional may recommend inserting the Cannula into another part of your body.

- a. Choose an area (see *Figure R*) at least 2 inches (5 cm) from the belly button and at least 1 inch (2.5 cm) from the previous insertion site. Change the infusion site every time you change the Infusion Set, trying not to repeat the last used site for at least 12 days.

Note: Keep at least 2 inches (5 cm) from the site of any areas of scarred or hardened tissue, stretch marks, skin folds or creases where the body naturally bends (e.g., while sitting or exercising), or to areas where clothing might cause irritation (e.g., near the belt-line).

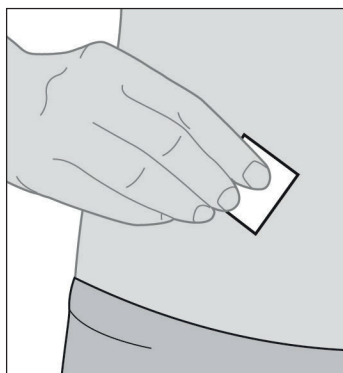

Figure S

2. Wipe the infusion site with an Alcohol Pad (see *Figure S*).

- a. Let the infusion site dry for at least 1 minute.

Note: It is important to allow it to dry fully or else the adhesive liner may not stick to the skin.

3. Insert Cannula into the body **ONLY**.



Infusion Set

Please refer to your ***Infusion Set Instructions For Use*** for detailed steps.

Note: After inserting the Cannula, be sure to pat down the adhesive liner to ensure it is stuck securely to the skin.

Note: After the Cannula is attached, you should check it regularly to ensure that there is no fluid leaking out on the skin. If the adhesive liner becomes loose, replace the Cannula as this may mean that the Cannula is not completely inserted under the skin.

Note: If the Infusion Set Tubing and Insertion Device/Cannula are packaged individually and you need only one of them, you can save the other for later use. If they are packaged together, the unused one must be discarded.

2.8 Connect Infusion Set Tubing to Cannula



Infusion Set

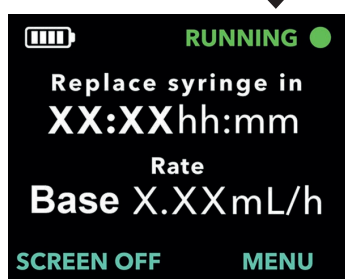
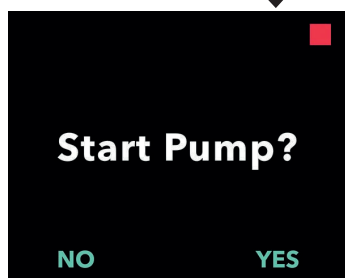
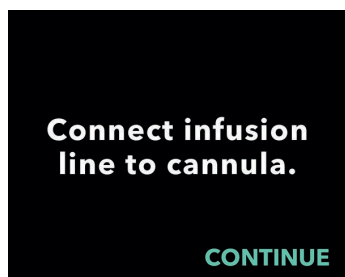

1. Connect Infusion Set Tubing to Cannula.

Please refer to your *Infusion Set Instructions For Use* for detailed steps.

2. Confirm the Infusion Set Tubing is connected to the Cannula.

- a. Press CONTINUE. The Pump will return to the Status Screen.

Note: When connecting the Infusion Set Tubing to the Cannula, make sure it snaps securely in place to prevent leakage.

3. Start Pump.

Note: When the Infusion Set Tubing is connected to the body, **do NOT** leave the Infusion Set Tubing hanging loose because it could accidentally catch on objects, possibly resulting in the Cannula becoming detached from the infusion site.

3. Administer Therapy

3.1 Start Continuous Infusion Delivery

Note: Always perform the following checks prior to starting an infusion:

1. Verify that the Infusion Set Tubing is correctly connected to the Syringe.
2. Verify that the Infusion Line has no kinks or other blockage.

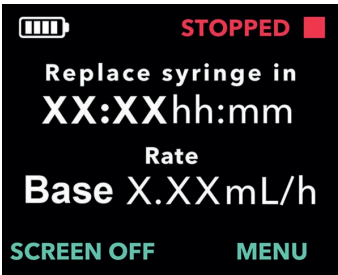

1. Turn on the Pump Display.

- a. Press any button (Arrow Keys or Selection Buttons).
- b. Press MENU to display the Pump Menu options.

Note: The Pump will display the time remaining until the Syringe is empty at the current Rate OR the time remaining until the PRODUODOPA™ remaining in the Syringe should be discarded and replaced with a new Syringe.

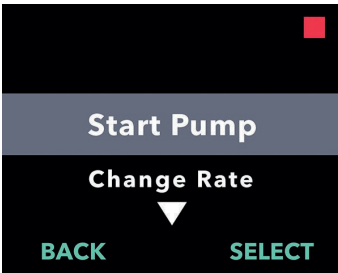

2. Choose the Start Pump menu option.

- a. Press SELECT.

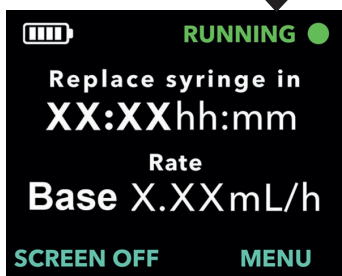
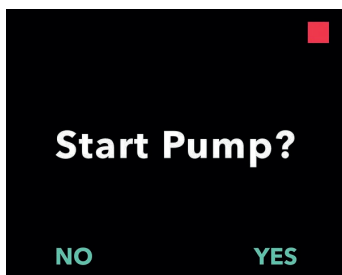

Carrying Accessory

3. Confirm Pump start.

- a. Press YES.

Note: If Loading Dose is configured on your Pump AND if the Loading Dose Lockout Time has elapsed, the Pump will display a screen to allow a Loading Dose. Unlike Extra Dose, there is no way to start the Loading Dose until the Pump displays that it is available (see section **Administer Loading Dose**).

4. Insert Pump into Carrying Accessory.

Please refer to your **Carrying Accessory Instructions For Use** for detailed steps.

Note: **Do NOT** use the Carrying Accessory if it is damaged.

3.2 Stop and Resume Therapy

Note: If therapy is stopped for more than 1 hour, replace the Cannula and Infusion Set Tubing or blockage may occur. If you replace the tubing, remember to prime it.



1. Turn on the Pump Display if needed.

- Press any button (Arrow Keys or Selection Buttons).
- Press MENU to display the Pump Menu options.

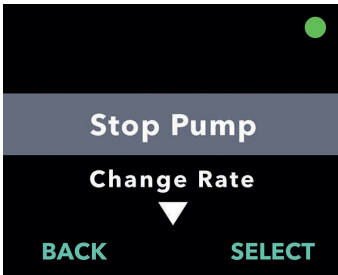

2. Choose the Stop Pump menu option.

- Press SELECT.

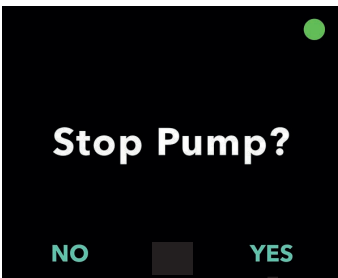

3. Confirm Pump stop.

- Press YES.

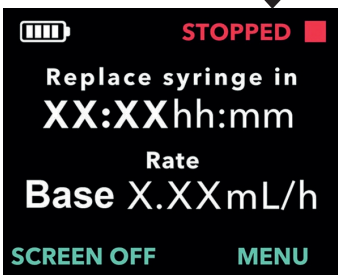

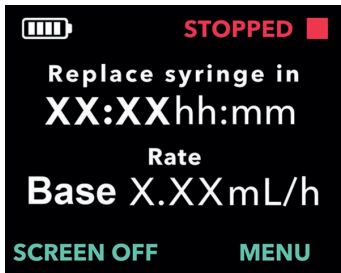

4. When ready, resume the therapy.

- a. Press MENU to display the Pump Menu options.

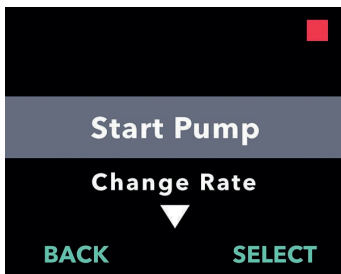

5. Start the Pump.

- a. Press SELECT.

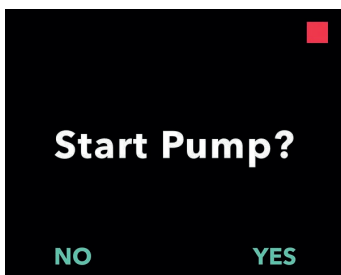

6. Confirm Pump start.

- a. Press YES.



3.3 Change Rate

Note: Your Pump may be set up to allow you to change the Flow Rate. Contact your Healthcare Professional if you are unsure if this option is available.

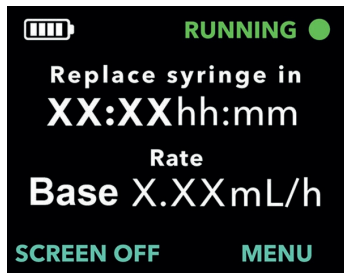

1. Turn on the Pump Display if needed.

- Press any button (Arrow Keys or Selection Buttons).
- Press MENU to display the Pump Menu options.

Note: The Pump does not need to be stopped in order to change the rate.

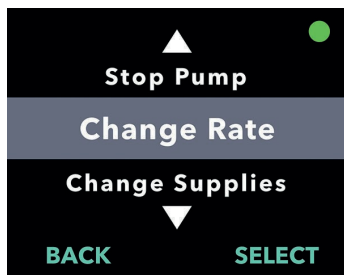

2. Use the Arrow Keys to highlight the *Change Rate* menu option.

- Press SELECT to choose the option to *Change Rate* and then follow the instructions on the Display.

Note: If this option has not been programmed by your Healthcare Professional, this menu option will not be displayed.

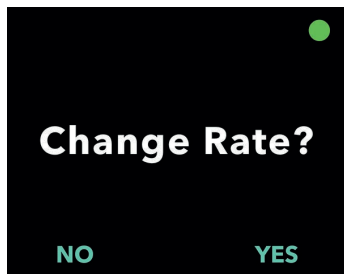

3. Confirm you want to change the Rate.

- Press YES.

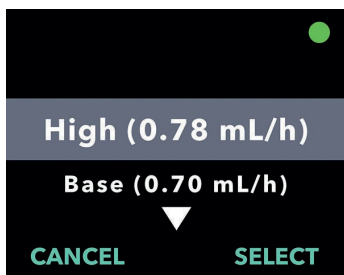

4. Use the Arrow Keys to select the desired Rate.

- a. Press SELECT to choose the highlighted Rate.

Note: The available Rate options will depend upon the prescription provided by your Healthcare Professional. In addition to the Base Rate, you may also have a High and/or Low Rate. Only the Rates prescribed by your Healthcare Professional will be displayed on your Pump screen.

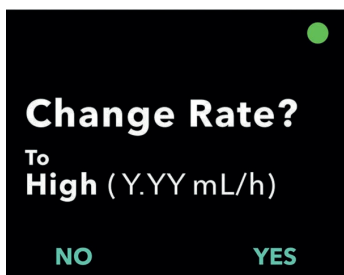

5. Confirm Rate change.

- a. Press YES. The Pump should now display the new Rate on the Status Screen.

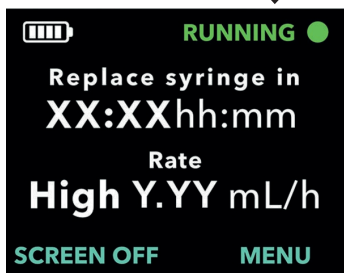

3.4 Administer Extra Dose

Note: Your Pump may be set up to allow you to administer an Extra Dose. Contact your Healthcare Professional if you are unsure if this option is available.

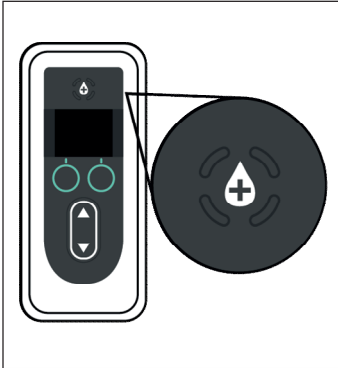

Figure T

1. While the Pump is delivering a Continuous Infusion, press the Extra Dose Button (see Figure T).

Note: The Pump must be delivering Continuous Infusion in order to administer an Extra Dose.

Note: If it is too soon for the next Extra Dose (Extra Dose locked out), the Display will show *Extra Dose will be available in: xx:yy*.

Note: When you administer a Loading Dose, the Extra Dose lock-out timer will be restarted.

Note: If the Extra Dose feature is not available, the Display will show *Extra Dose is not enabled*.

Note: If there is not enough PRODUODOPA™ remaining in the Syringe to give an Extra Dose, you will need to change the Syringe before an Extra Dose can be delivered.

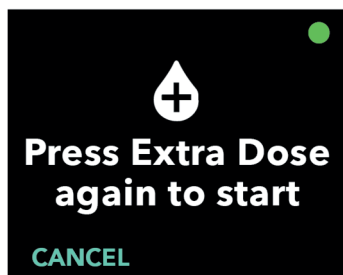

2. Start the dose.

- a. Press the Extra Dose Button a second time.

Note: The Pump will emit a tone indicating the start of the Extra Dose.

Note: A status bar will appear that will fill with white to show the progress of the Extra Dose being delivered.

Note: The Pump will emit a tone when Extra Dose is complete.

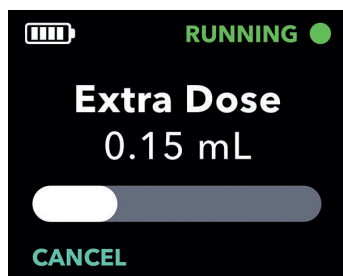

3. Press OK when the Extra Dose is complete to return to the Status Screen.

Note: If you **do NOT** press OK within 20 seconds, the Pump will automatically resume your Continuous Infusion.

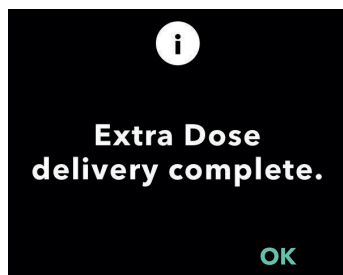

3.5 Stop/Cancel Extra Dose Delivery

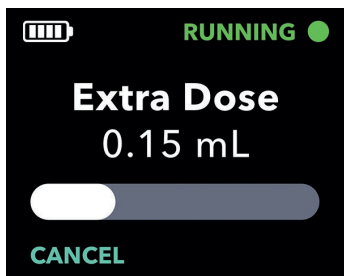

1. Cancel the Extra Dose after it has started.

- a. Press CANCEL.

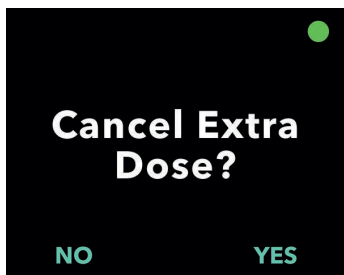

2. Confirm cancel Extra Dose.

- a. Press YES.

Note: If the Extra Dose is canceled, it cannot be resumed. The next Extra Dose cannot be started until the Lockout Time has elapsed.

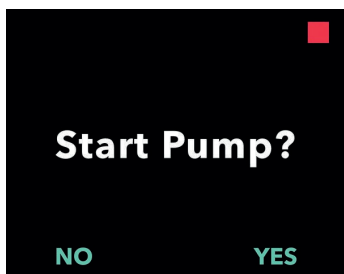

3. Resume Continuous Infusion.

- a. Press YES.

Note: Press NO only if you **do NOT** want to resume the Continuous Infusion.

3.6 Administer Loading Dose

Note: Your Pump may be configured to offer you a Loading Dose when the Pump has not been administering a therapy for an extended period of time.

Note: Recall that if therapy is stopped for more than 1 hour, you must replace the Cannula and Infusion Set Tubing or blockage may occur. If you replace the tubing, remember to prime it.

Note: To see if Loading Dose is available, you must select "Start Pump." If Loading Dose is available, the display screen will provide it as an option. There is no way to start Loading Dose unless the Pump displays that it is available.

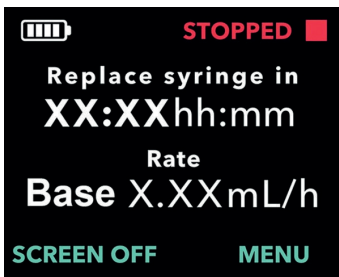

1. Turn on the Pump Display.

- Press any button (Arrow Keys or Selection Buttons).
- Press MENU to display the Pump Menu options.

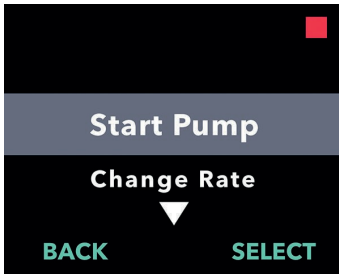

2. Choose the Start Pump menu option.

- Press SELECT.

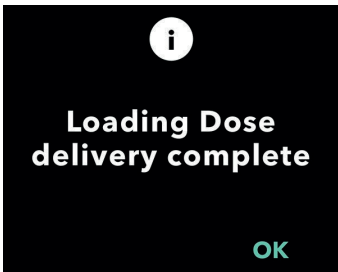
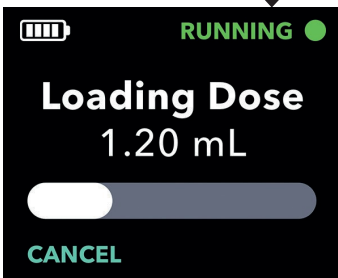
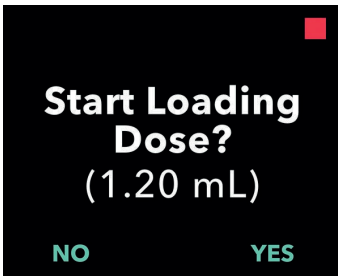

3. Start Loading Dose.

- a. Press YES.

Note: A progress bar will appear and begin to show the progress of the Loading Dose being delivered.

Note: If the Lockout Time from the previous Loading Dose has not passed, the Pump will not provide the option to start a Loading Dose.

- b. After Loading Dose has completed delivery, the Continuous Infusion will start automatically. Press OK to return to the Status Screen.

Note: If you **do NOT** press OK, the Display will automatically return to the Status Screen after 20 seconds.

3.7 Stop/Cancel Loading Dose

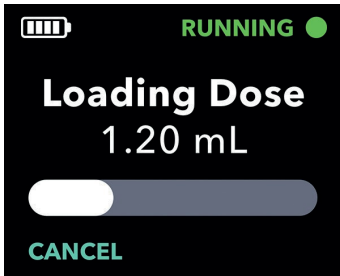

1. Cancel the Loading Dose after it has started.

- a. Press CANCEL.

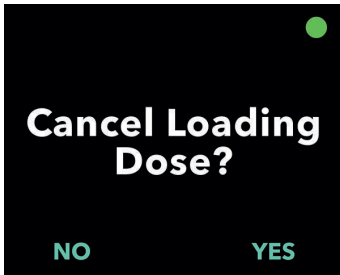

2. Confirm cancel Loading Dose.

- a. Press YES. The Pump will return to its stopped state.

Note: If the Loading Dose is canceled, the Pump will stop delivery and will not automatically start the Continuous Infusion.

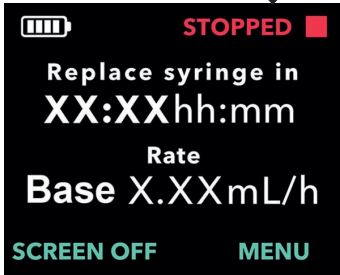

3.8 Resume Loading Dose

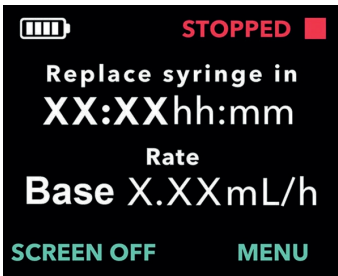

1. Turn on the Pump Display.

- Press any button (Arrow Keys or Selection Buttons).
- Press MENU to display the Pump Menu options.

Note: If after canceling the Loading Dose, you begin to run a Continuous Infusion, the Pump will not display the Loading Dose option until the Lockout Time has expired.

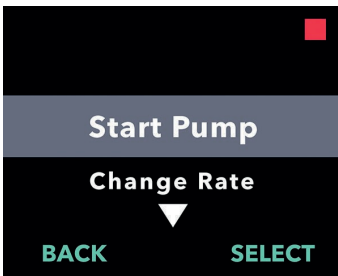

2. Choose the Start Pump menu option.

- Press SELECT.

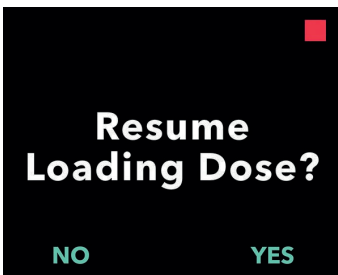

3. Resume Loading Dose.

- Press YES.

Note: The Loading Dose will continue from the point where it was canceled.

Note: Selecting NO will provide the option to start a Continuous Infusion.

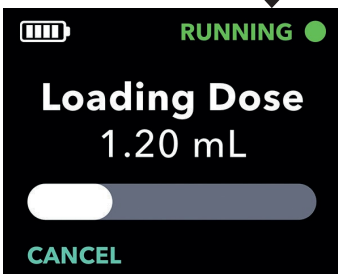

3.9 Choosing to Not Start Loading Dose

Note: If you select NO, the Pump will prompt you to confirm you **do NOT** want the Loading Dose and want to start the Continuous Infusion.

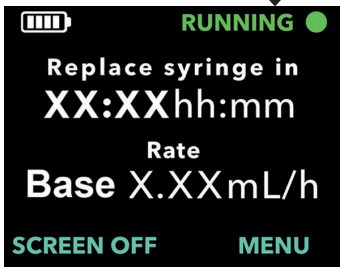
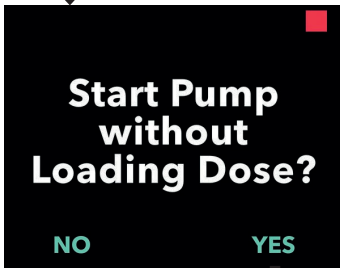
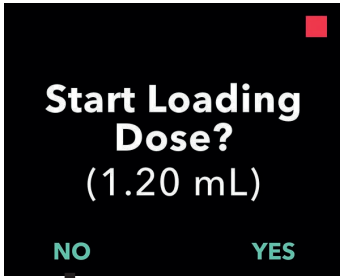

4. Disconnect from Pump (less than 1 hour) and Reconnect



Infusion Set

Please refer to your **Infusion Set Instructions for Use** in this section.

4.1 Stop Therapy

You will need to temporarily disconnect from your Pump, for example, when taking a shower. This is done by stopping the Pump, disconnecting the site connector from the Cannula, and tapping away any drips from the site connector.

Note: If therapy is stopped for more than 1 hour, replace the Cannula and Infusion Set Tubing or blockage may occur. If you replace the tubing, remember to prime it.

Warning: To minimize the risk of infections, **do NOT** let the tip of any disposable component come into contact with any unclean surfaces. If a tip of the Infusion Set Tubing or Syringe comes into contact with an unclean surface, discard it and get a new one.



1. Turn on the Pump Display if needed.

- Press any button (Arrow Keys or Selection Buttons).
- Press MENU to display the Pump Menu options.

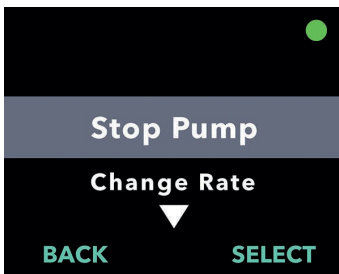

2. Choose the Stop Pump menu option.

- Press SELECT.

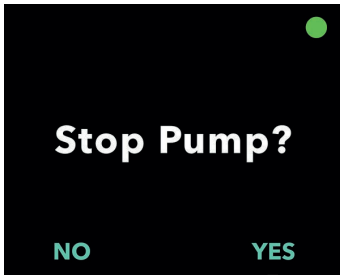

3. Confirm Pump stop.

- a. Press YES.

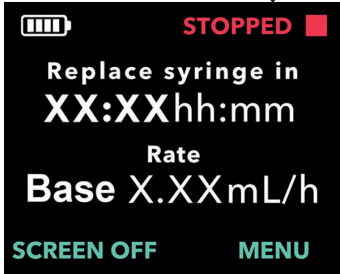

4.2 Disconnect from Site Connector and Remove Drips



Infusion Set

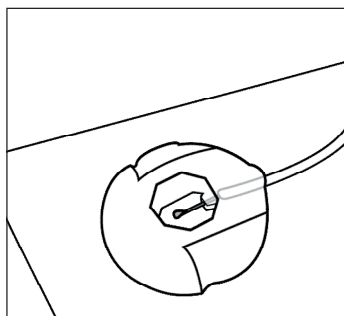

Figure U



Figure V

1. Disconnect the Infusion Set Tubing from the Cannula.

Please refer to your **Infusion Set Instructions For Use** for detailed steps on disconnection.

- a. After the Infusion Set tubing is disconnected from the Cannula, **ensure the needle tip of the connector is exposed** and not touching any unclean surfaces.
- b. Place the connector onto a clean paper towel to ensure it remains clean (see *Figure U*).

Note: When you are disconnected and the Pump is not being used, keep the connector on the clean paper towel until you are ready to reconnect.

- c. Hold the tubing and Site Connector in place with one hand, wait 60 seconds for the drips to stop, and then tap the connector to remove any drops (see *Figure V*).

Note: Some infusion sets come with protective caps allowing you to recap the site connector and recap the Cannula while disconnected.

4.3 Resume Therapy (within 1 hour)

1. When you are ready to resume therapy, ensure there are no drops on the needle tip.
2. Without lifting the connector from the paper towel, tap the site connector with your finger so that any drops break free from the needle tip.

Note: Before attaching the connector to the Cannula, make sure it is free of drops or it may later be difficult to detach from the Cannula.



Infusion Set

3. Reconnect the Infusion Set Tubing to the Cannula.

Please refer to your *Infusion Set Instructions For Use* for detailed steps.

- a. Lift the site connector off of the Paper Towel.
- b. Reconnect the Site Connector to the Cannula.

Note: If you see a hanging drop from the needle, put the site connector back on the Paper Towel and tap the connector to remove the hanging drop.

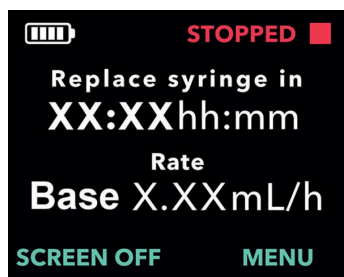

4. Restart the Continuous Infusion.

- a. Press MENU to display the Pump Menu options.

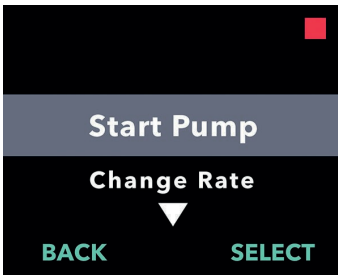

5. Choose the **Start Pump** menu option.

a. Press **SELECT**.

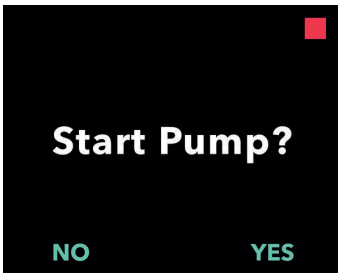

6. Confirm **Pump start**.

a. Press **YES**.



THIS PAGE IS INTENTIONALLY LEFT BLANK.

5. Replace Syringe Only



Preparing Solution, Carrying Accessory, and Infusion Set

Please refer to your ***Preparing Solution Instructions for Use, Carrying Accessory Instructions for Use, and Infusion Set Instructions for Use*** in this section.

You will change your Syringe at least every 24 hours, either because 24 hours has elapsed since the Syringe was inserted into the Pump or because the Syringe is empty or nearly empty.

Note: If you are replacing only the Syringe and are using the same tubing, you will not need to prime because the tubing will already be filled with the PRODUODOPA™.

Note: In order to maintain PRODUODOPA™ delivery without interruption, you should prepare your new Syringe while the Pump is delivering PRODUODOPA™. The Infusion Set Tubing can stay connected to the Cannula when you are replacing the Syringe only.

Note: If therapy is stopped for more than 1 hour, replace the Cannula and Infusion Set Tubing or blockage may occur. If you replace the tubing, remember to prime it.

5.1 Gather Supplies

1. Select a clean, flat well-lit workspace.

Note: To minimize the risk of infection, ensure your work surface is clean.

2. Gather supplies, including (see *Figure W*):

- Pump
- Syringe
- New, Unused Paper Towels
- Solution Vial
- Vial Adapter*
- Alcohol Pads

Note: Always ensure that you have replacements for all of your disposable components.

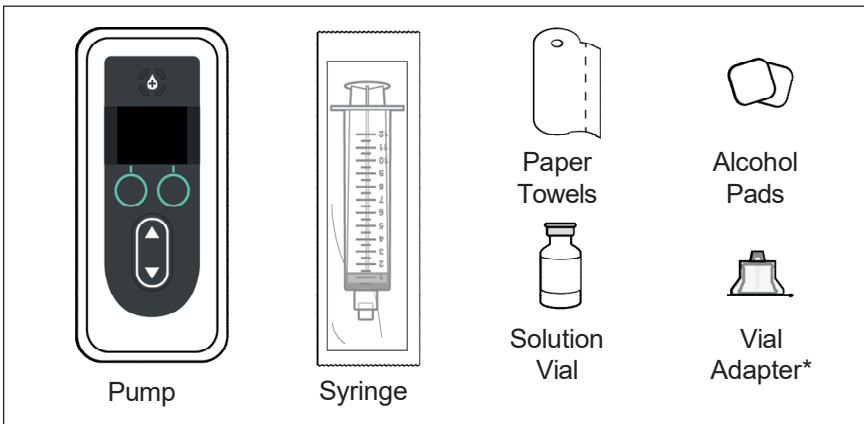

Figure W

*Your Vial Adapter may look different from the one illustrated in *Figure W*.

Note: If refrigerated, ensure the Solution Vial has been warming at room temperature for 30 minutes before filling the Syringe.

3. Inspect components.

- a. Inspect and verify that all components have not expired and that there is no damage to any of the packaging. If any of the components have expired or if the packaging is damaged, **do NOT** use, and contact your Healthcare Professional.
- b. Inspect the contents of the Solution Vial and verify that you **do not** see cloudiness or particles in the liquid.

Note: The product packaging for the Vial Adapter and Syringe indicate that they are sterile and how they were sterilized.

⚠ Warning: Verify that the solution is the PRODUODOPA™ prescribed by your Healthcare Professional.

⚠ Warning: Check expiration date for all disposable components. **Do NOT** use component if it is expired.

⚠ Warning: **Do NOT** use any disposable components if their sterile packaging has been damaged prior to use.

Caution: Inspect all disposable components before use and **do NOT** use any of them if they are damaged.

Caution: **Do NOT** use the PRODUODOPA™ if it is cloudy or contains flakes or particles.



Figure X

4. Wash your hands with soap and water and dry them (see Figure X).

5.2 Fill Syringe with PRODUODOPA™

1. Select a clean, flat well-lit workspace.

Note: To minimize the risk of infection, ensure your work surface is clean.

Note: When changing supplies, it is important to follow the display screens in order to ensure that the Pump is properly set up for the infusion.



Preparing Solution

2. Prepare the Syringe.

Please refer to your ***Preparing Solution Instructions For Use*** for detailed steps on how to:

- Connect the Vial Adapter to the Solution Vial
- Transfer the PRODUODOPA™ from the Solution Vial to the Syringe
- Remove air bubbles
- Purge all air from the Syringe

5.3 Stop Therapy



*Carrying
Accessory*

1. Remove the Pump from the Carrying Accessory.

Please refer to your ***Carrying Accessory Instructions For Use*** for detailed steps.

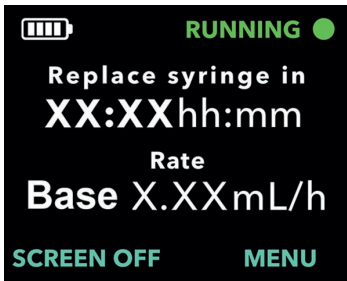

2. Turn on the Pump Display.

- Press any button (Arrow Keys or Selection Buttons).
- Press MENU to display the Pump Menu options.

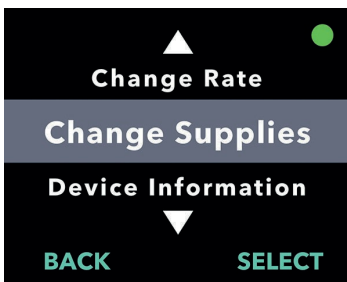

3. Use the Arrow Keys to highlight the *Change Supplies* menu option.

- Press SELECT to choose the option to Change Supplies and then follow the instructions on the Display.

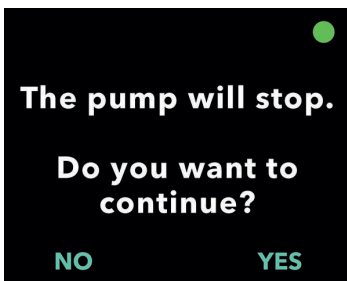

4. Stop the infusion.

- Press YES.

5.4 Remove Used Syringe from Pump

Note: When the screen displays the selectable option of "Remove Syringe," select that option before opening the Pump lid.



1. Choose the Remove Syringe menu option.

- a. Press SELECT.

Note: After selecting the Remove Syringe menu option, **do NOT** open lid until indicated on the display (see step 3).

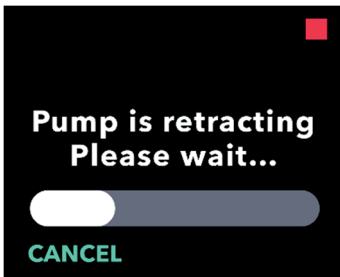

2. Pause to allow the Plunger Rod Pusher to retract.

Note: The Status Bar indicates the progress of the Plunger Rod Pusher while it is retracting.

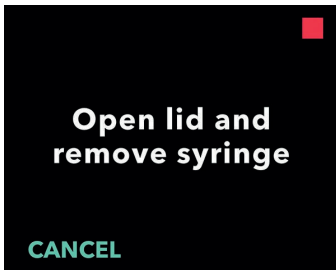

3. When the Pump Display prompts you (see *Figure Y*), open the Lid of the Pump and remove the used Syringe.

Figure Y

5.5 Replace the Syringe

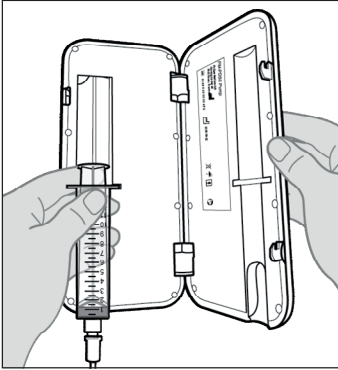

Figure Z

1. Remove the used Syringe from the Pump (see *Figure Z*).

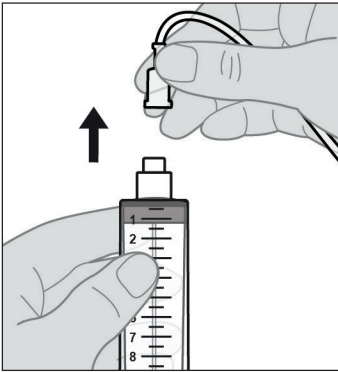

Figure AA

2. Disconnect Infusion Set Tubing from the used Syringe (see *Figure AA*).
3. Discard the used Syringe per local regulations.

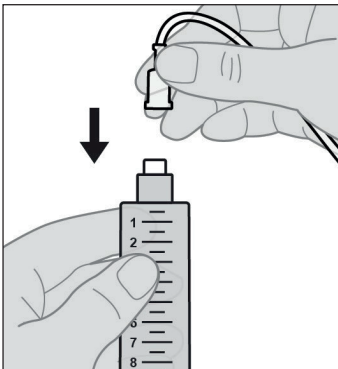

Figure AB

4. Attach the Infusion Set Tubing to the new Syringe (see *Figure AB*).

5.6 Place New Syringe in Pump

Note: When replacing only the Syringe and not the tubing, you **do NOT** need to prime the tubing.

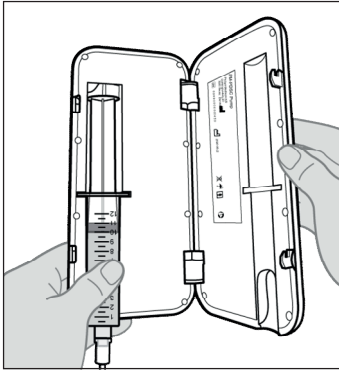

Figure AC

1. Place the new Syringe into the Pump.

- a. Place the Syringe into the Pump groove with the Syringe flanges in the Syringe Flange Grooves (see *Figure AC*).

Note: The Syringe should fit into the Pump groove with little to no resistance. If the Syringe does not fit inside the Pump groove, check to see if the Syringe plunger has been advanced to the correct position and air has been removed.

Note: Ensure the Syringe is correctly seated in the Pump before closing the Pump Lid.

If the Syringe does not fit into the Pump because there is still air in the Syringe tip, make sure the tubing is not connected to the Cannula, and then carefully push out the remaining air, being careful not to also push out any of the PRODUODOPA™.

Close the Pump Lid until it snaps shut and the Syringe is secured in place.

**Insert new
syringe if desired.
Close lid.**

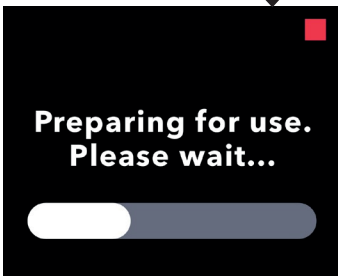
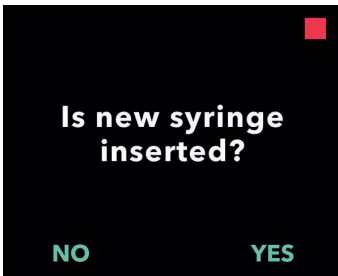

2. Confirm that the new Syringe has been inserted.

- a. Press YES.
- b. Pause to allow the Pump to prepare the new Syringe for use.

5.7 Resume Continuous Infusion Delivery

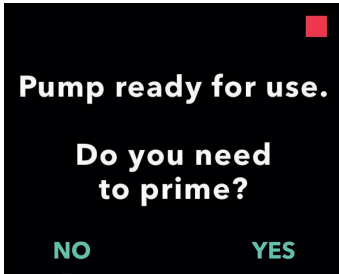

Note: If you replaced only the Syringe and not the tubing, select NO because you **do NOT** need to prime the tubing.

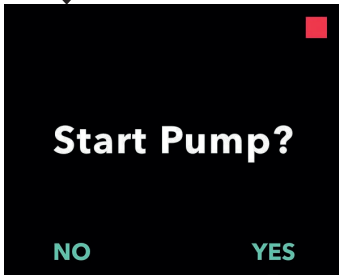

1. Start Pump.

Note: Ensure your Infusion Set Tubing is connected to the Cannula before starting the Pump.

Note: Always perform the following checks prior to starting an infusion:

1. Verify that the Infusion Set is correctly connected to the Syringe.
2. Verify that the Infusion Line has no kinks or other blockage.



6. Replace Infusion Set Tubing and Cannula (not Syringe)



Infusion Set and Insertion Device

Please refer to your **Infusion Set Instructions for Use** and **Insertion Device Instructions for Use** in this section.

The Cannula and Infusion Set Tubing must be changed at regular intervals, as per the instructions from your Healthcare Professional, or when there is a blockage or leak that cannot be remedied any other way.

6.1 Gather Supplies

1. Select a clean, flat well-lit workspace.

Note: To minimize the risk of infection, ensure your work surface is clean.

2. Gather supplies (see *Figure AD*).

- Pump
- Infusion Set
- Insertion Device
- Alcohol Pads
- New, Unused Paper Towels

Note: Always ensure that you have replacements for all of your disposable components.

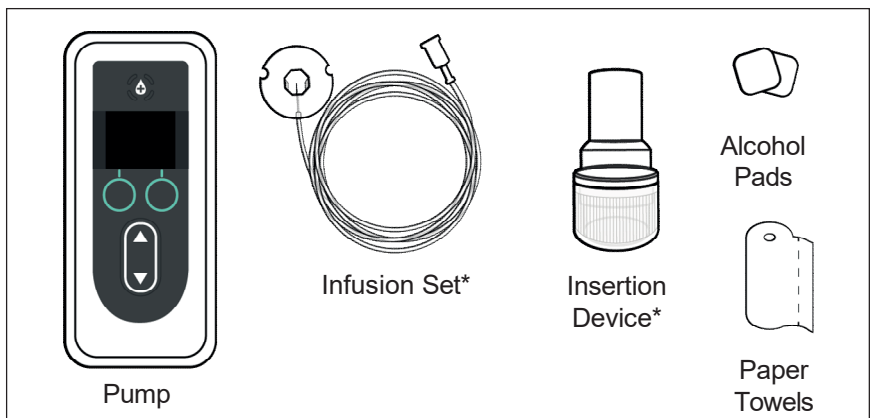

Figure AD

*Your Insertion Device and Infusion Set may look different from the ones illustrated in *Figure AD*.

3. Inspect components for expiration and for any packaging damage.

Note: The product packaging for the Infusion Set indicates that it is sterile and how it was sterilized.

Warning: Check expiration date for all disposable components. **Do NOT** use component if it is expired.

Warning: **Do NOT** use any disposable components if their sterile packaging has been damaged prior to use.

Caution: Inspect all disposable components before use and **do NOT** use any of them if they are damaged.

Caution: **Do NOT** use the PRODUODOPA™ if it has been in the Syringe for more than 24 hours.



4. Wash your hands with soap and water and dry them (see *Figure AE*).

Figure AE

6.2 Stop Therapy



1. Turn on the Pump Display if needed.

- Press any button (Arrow Keys or Selection Buttons).
- Press MENU to display the Pump Menu options.

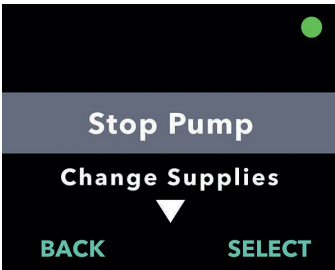

2. If the Pump is running, press SELECT to choose the Stop Pump menu.

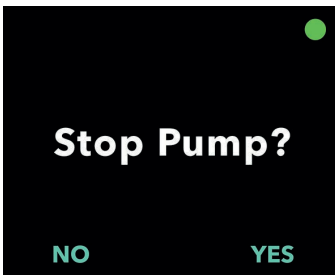

3. Confirm Pump stop.

- Press YES.

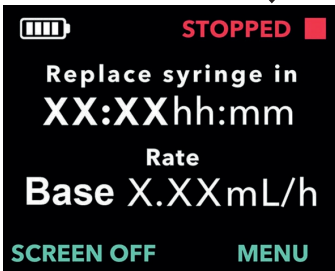

6.3 Remove Cannula and Disconnect Infusion Set Tubing from Syringe



Infusion Set

1. Remove Cannula and disconnect Infusion Set Tubing from Syringe.

Please refer to your *Infusion Set Instructions For Use* for detailed steps.

2. Discard the used Infusion Set Tubing and Cannula per local regulations.

6.4 Connect New Infusion Set Tubing



Infusion Set

1. Remove Infusion Set Tubing from the package.

Please refer to your *Infusion Set Instructions For Use* for detailed steps.

2. Attach the Infusion Set Tubing to the Syringe.

- a. While holding the Pump firmly, attach the Infusion Set Tubing to the Syringe and twist until snug (see *Figure AF*).

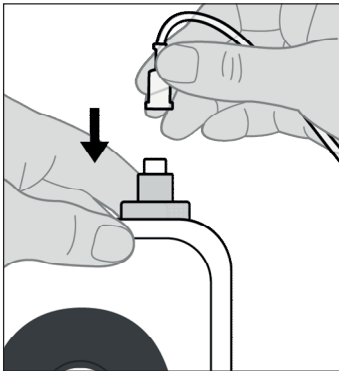
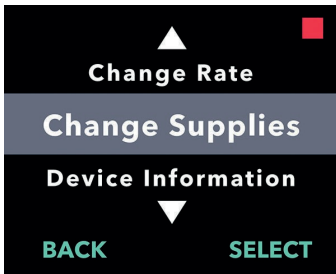

Figure AF

Warning: To minimize the risk of infections, **do NOT** let the tip of any disposable component come into contact with any unclean surfaces. If a tip of the Infusion Set Tubing or Syringe comes into contact with an unclean surface, discard it and get a new one.

6.5 Prime Infusion Set Tubing



1. Select **MENU**, then use the **Arrow Keys** to highlight the **Change Supplies** menu option.
 - a. Press **SELECT** to choose the option to *Change Supplies* and then follow the instructions on the Display.

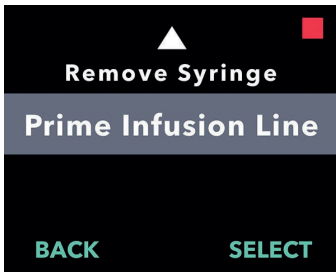

2. Use the **Arrow Keys** to highlight the **Prime Infusion Line** menu option.
 - a. Press **SELECT** to enter menu.

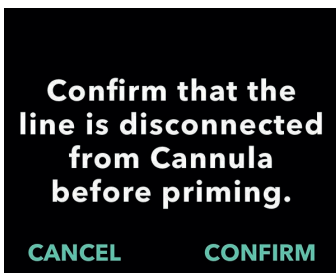

3. Confirm the Infusion Line is **NOT** connected to the Cannula.
 - a. Press **CONFIRM**.

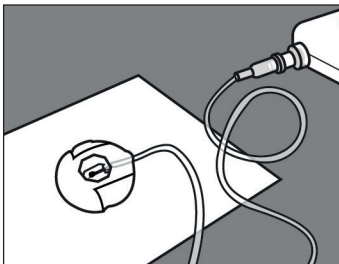

Figure AG

4. Prepare to prime the Infusion Set.
 - a. Lay the needle end of the Infusion Set on a clean Paper Towel so that the drops will fall on the Paper Towel and will not fall onto any part of the connector (see *Figure AG*).

Note: Your Infusion Set may look different from the one illustrated here.

Note: Ensure that the site connector remains on the clean paper towel while priming.



Figure AH

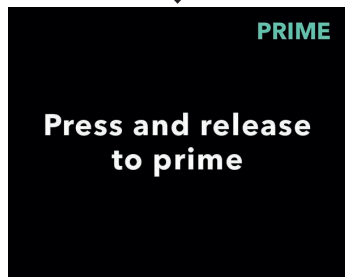

5. Prime the Infusion Set.

- a. Hold the Pump with the Syringe tip straight up (see *Figure AH*).

Note: The Display will rotate so that you can read it when the Pump is held this way for priming.

- b. Press PRIME.

Note: The Pump must be pointing straight up and not tilted or the option PRIME will not appear. Make sure the Pump is not tilted.

Note: If the Pump is tilted slightly, the display will indicate the Syringe tip must point straight up in order to be able to prime.

Note: Each time you press PRIME, the Pump will deliver a volume of Solution into the infusion set and stop. (Continue on next page.)



Figure AI

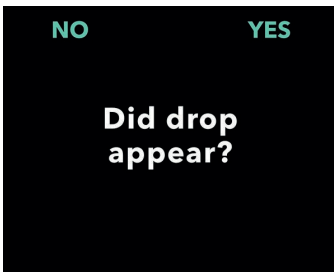
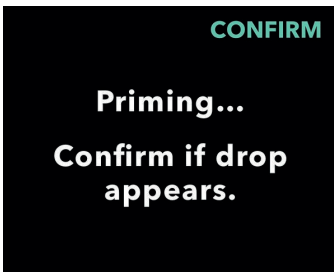

Figure AJ

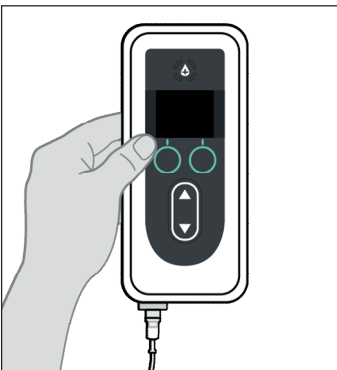

Figure AK

6. Look for a drop of PRODUODOPA™ on the site connector needle (see *Figure AI*).

- a. Press CONFIRM when you see a drop of PRODUODOPA™ on the site connector needle.
- b. Press YES to confirm the appearance of the drop.

Note: It may take several seconds for the drop to appear.

Note: If CONFIRM is not pressed, you will be asked if a drop appeared (see *Figure AJ*).

Note: Pressing NO will return you to the "Press and release to prime" screen, allowing you to continue priming until a drop appears.

7. Return the Pump to its original orientation (see *Figure AK*) and place flat on the table.

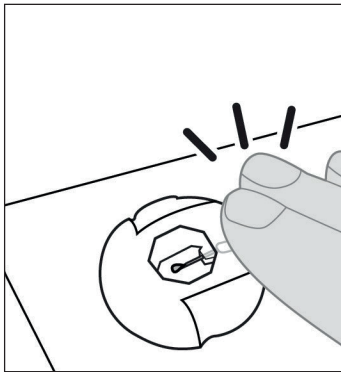

Figure AL

8. **After 60 seconds, tap the site connector with your finger, so any drops break free from the needle (see Figure AL).**

Note: Before attaching the connector to the Cannula, make sure it is free of drops or it may later be difficult to detach from the Cannula.

Note: Some infusion sets come with protective caps, allowing you to recap the site connector and recap the Cannula until it is time to connect them.

6.6 Insert Cannula into the Body

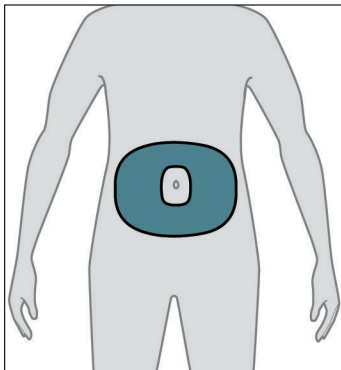

Figure AM

1. **Select your desired infusion site.**

Note: The following instructions describe how to insert the Cannula into your abdomen. In some cases, your Healthcare Professional may recommend inserting the Cannula into another part of your body.

- a. Choose an area (see Figure AM) at least 2 inches (5 cm) from the belly button and at least 1 inch (2.5 cm) from the previous insertion site. Change the infusion site every time you change the Infusion Set, trying not to repeat the last used site for at least 12 days.

Note: Keep at least 2 inches (5 cm) from the site of any areas of scarred or hardened tissue, stretch marks, skin folds or creases where the body naturally bends (e.g., while sitting or exercising), or to areas where clothing might cause irritation (e.g., near the belt-line).

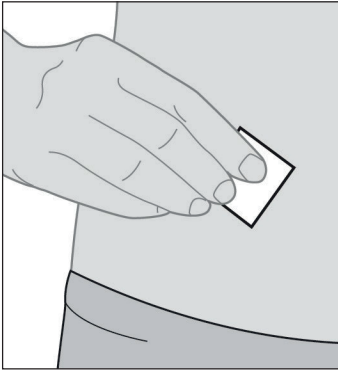

Figure AN

2. Wipe the infusion site with an Alcohol Pad (see *Figure AN*).

- a. Let the infusion site dry for at least 1 minute.

Note: It is important to allow it to dry fully or else the adhesive liner may not stick to the skin.



Infusion Set

3. Insert Cannula into the body ONLY.

Please refer to your *Infusion Set Instructions For Use* for detailed steps.

Note: After inserting the Cannula, be sure to pat down the adhesive liner to ensure it is stuck securely to the skin.

Note: After the Cannula is attached, you should check it regularly to ensure that there is no fluid leaking out on the skin. If the adhesive liner becomes loose, replace the Cannula as this may mean that the Cannula is not completely inserted under the skin.

Note: If the Infusion Set Tubing and Insertion Device/Cannula are packaged individually and you need only one of them, you can save the other for later use. If they are packaged together, the unused one must be discarded.

6.7 Connect Infusion Set Tubing to Cannula and Resume Continuous Infusion Delivery



Infusion Set

1. Connect Infusion Set Tubing to Cannula.

Please refer to your *Infusion Set Instructions For Use* for detailed steps.

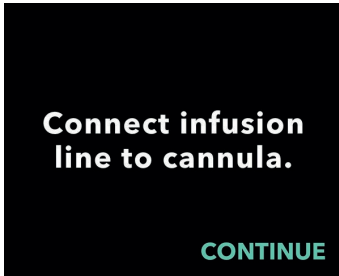

2. Confirm the Infusion Set Tubing is connected to the Cannula.

- a. Press CONTINUE. The Pump will return to the Status Screen.

Note: When connecting the Infusion Set Tubing to the Cannula, make sure it snaps securely in place to prevent leakage.

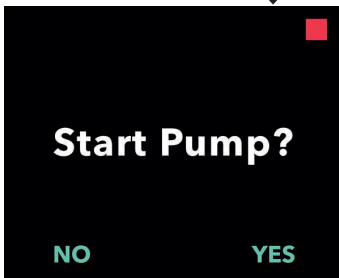

3. Confirm Pump start.

- a. Press YES.

Optional: Place Pump into the Carrying Accessory.

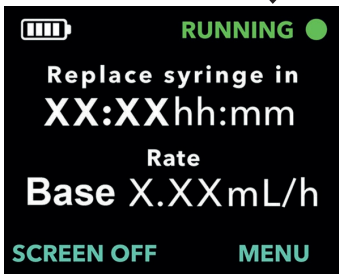

7. Replace Syringe, Infusion Set Tubing, and Cannula



Preparing Solution, Carrying Accessory, and Infusion Set

Please refer to your ***Preparing Solution Instructions for Use, Carrying Accessory Instructions for Use, and Infusion Set Instructions for Use*** in this section.

The Cannula and Infusion Set Tubing must be changed at regular intervals, as per the instructions from your Healthcare Professional. You may also replace the Syringe at that time.

Note: In order to maintain PRODUODOPA™ delivery without interruption, you should prepare your new Syringe while the Pump is delivering PRODUODOPA™.

7.1 Gather Supplies

1. Select a clean, flat well-lit workspace.

Note: To minimize the risk of infection, ensure your work surface is clean

2. Gather supplies, including (see *Figure AO*):

- Pump
- Syringe
- New, Unused Paper Towels
- Insertion Device*
- Solution Vial
- Vial Adapter*
- Alcohol Pads
- Infusion Set*

Note: Always ensure that you have replacements for all of your disposable components.

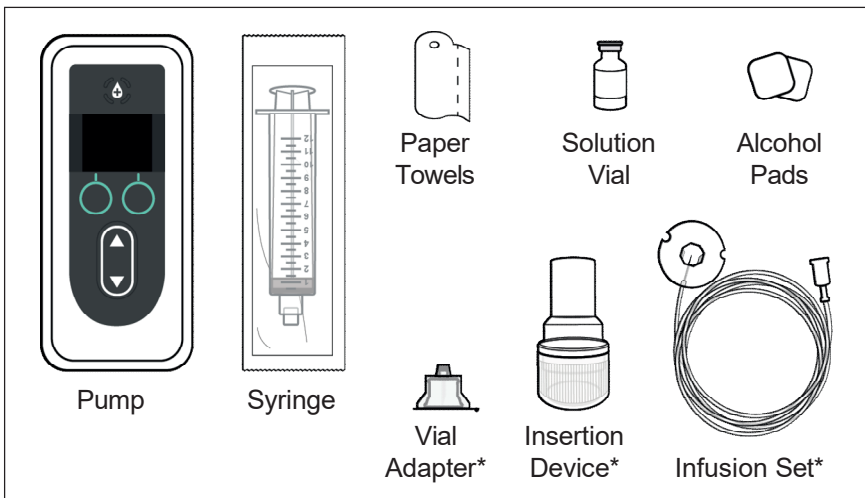

Figure AO

*Your Insertion Device, Infusion Set, and Vial Adapter may look different from the ones illustrated in *Figure AO*.

Note: If refrigerated, ensure the Solution Vial has been warming at room temperature for 30 minutes before filling the Syringe.

3. Inspect components for expiration and for any packaging damage.

- a. Inspect and verify that all components have not expired and that there is no damage to any of the packaging. If any of the components have expired or if the packaging is damaged, **do NOT** use, and contact your Healthcare Professional.
- b. Inspect the contents of the Solution Vial and verify that you **do not** see cloudiness or particles in the liquid.

Note: The product packaging for the Infusion Set, Vial Adapter and Syringe indicate that they are sterile and how they were sterilized.

Warning: Verify that the solution is the PRODUODOPA™ prescribed by your Healthcare Professional.

Warning: Check expiration date for all disposable components. **Do NOT** use component if it is expired.

Warning: **Do NOT** use any disposable components if their sterile packaging has been damaged prior to use.

Caution: Inspect all disposable components before use and **do NOT** use any of them if they are damaged.

Caution: **Do NOT** use the PRODUODOPA™ if it has been in the Syringe for more than 24 hours.

Caution: **Do NOT** use the PRODUODOPA™ if it is cloudy or contains flakes or particles.



Figure AP

4. Wash your hands with soap and water and dry them (see *Figure AP*).

7.2 Fill Syringe with PRODUODOPA™

1. Select a clean, flat well-lit workspace.

Note: To minimize the risk of infection, ensure your work surface is clean.



Preparing Solution

2. Prepare the Syringe.

Please refer to your **Preparing Solution Instructions For Use** for detailed steps on how to:

- Connect the Vial Adapter to the Solution Vial
- Transfer the PRODUODOPA™ from the Solution Vial to the Syringe
- Remove air bubbles
- Purge all air from the Syringe

7.3 Stop Therapy



Carrying Accessory

1. Remove the Pump from the Carrying Accessory.

Please refer to your **Carrying Accessory Instructions For Use** for detailed steps.

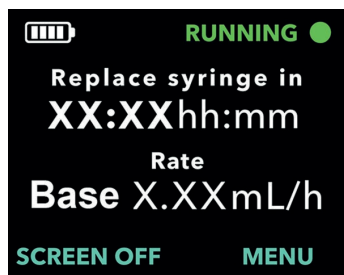

2. Turn on the Pump Display.

- a. Press any button (Arrow Keys or Selection Buttons).
- b. Press MENU to display the Pump Menu options.

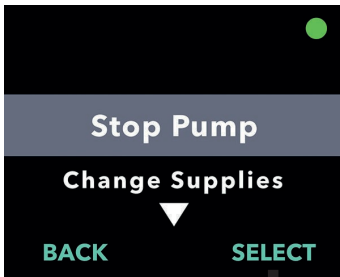

3. If the Pump is running, select the Stop Pump menu option.

- a. Press SELECT.

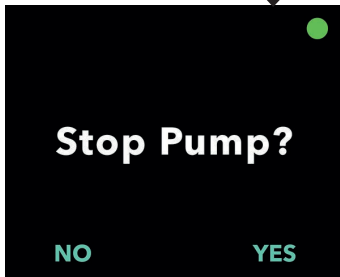

4. Confirm Pump stop.

- a. Press YES.



7.4 Remove Cannula from Infusion Site



Infusion Set

1. Remove Cannula.

Please refer to your *Infusion Set Instructions For Use* for detailed steps.

7.5 Remove the Used Syringe from Pump

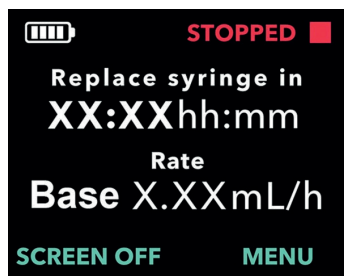

1. Turn on the Pump Display.
 - a. Press any button (Arrow Keys or Selection Buttons).
 - b. Press MENU to display the Pump Menu options.



2. Use the Arrow Keys to highlight the *Change Supplies* menu option.
 - a. Press SELECT to choose the option to *Change Supplies* and then follow the instructions on the Display.

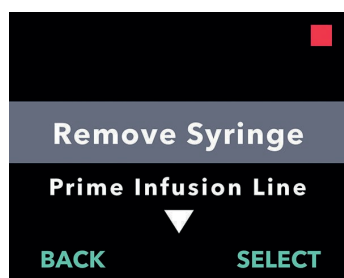

3. Choose the Remove Syringe menu option.
 - a. Press SELECT.

Note: After selecting the Remove Syringe menu option, **Do NOT** open lid until after selecting the *Remove Syringe* option.

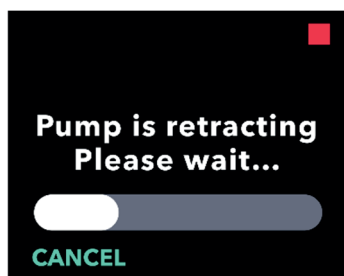

4. Pause to allow the Plunger Rod Pusher to retract.

**Open lid and
remove syringe**

CANCEL

5. When the Pump Display prompts you (see *Figure AQ*), open the Lid of the Pump and remove the used Syringe (see *Figure AR*).

Figure AQ

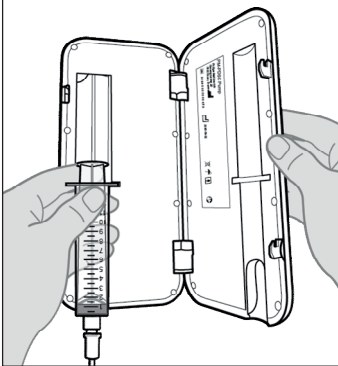

Figure AR

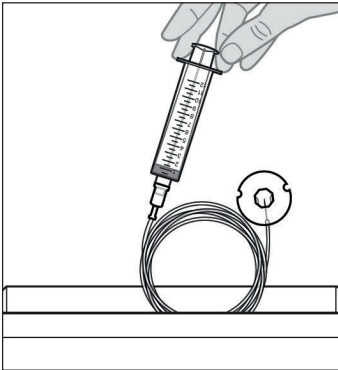

Figure AS

6. Discard the used Syringe and Infusion Set per local regulations (see *Figure AS*).

7.6 Connect New Infusion Set Tubing to New Syringe

1. Remove Infusion Set Tubing from the package.

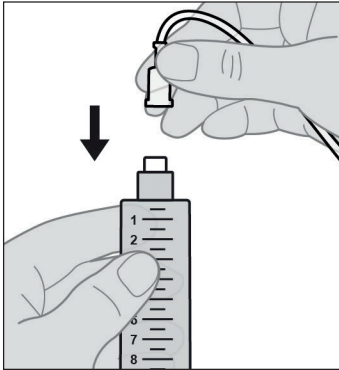

Figure AT

2. Attach the Infusion Set Tubing to a new filled Syringe (see *Figure AT*).

Note: If needed, refer to section **Fill Syringe with PRODUODOPA™**.

- Warning:** To minimize the risk of infections, **do NOT** let the tip of any disposable component come into contact with any unclean surfaces. If a tip of the Infusion Set Tubing or Syringe comes into contact with an unclean surface, discard it and get a new one.

7.7 Place New Syringe in Pump

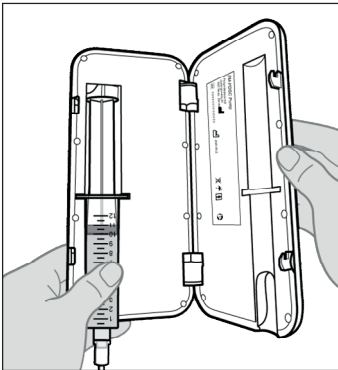

Figure AU

Insert new syringe if desired. Close lid.

Is new syringe inserted?

NO

YES

Preparing for use. Please wait...



1. Place the Syringe into the Pump.

- Place the Syringe into the Pump groove with the Syringe flanges in the Syringe Flange Grooves (see Figure AU).

Note: The Syringe should fit into the Pump groove with little to no resistance. If the Syringe does not fit inside the Pump groove, check to see if the Syringe plunger has been advanced to the correct position and air has been removed.

Note: Ensure the Syringe is correctly seated in the Pump before closing the Pump Lid.

If the Syringe does not fit into the Pump with a fully retracted Syringe Plunger Rod because there is still air in the Syringe tip, re-attach the Syringe to the Vial Adapter that is still attached to the Vial. With the Vial and Syringe pointed upward, slowly push all remaining air and a small amount of liquid back into the Vial. Then re-attach the Infusion Set Tubing and try again.

- Close the Pump Lid until it snaps shut and the Syringe is secured in place.

2. Confirm that the new Syringe has been inserted.

- Press YES.
- Pause to allow the Pump to prepare the new Syringe for use.

7.8 Prime Infusion Set Tubing

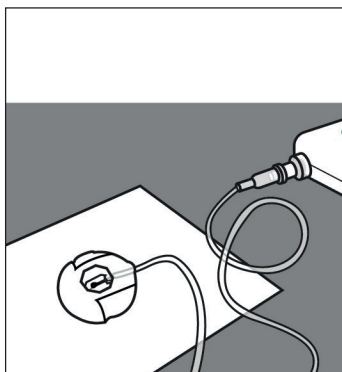

Figure AV

1. Prepare to prime the Infusion Set.

- a. Lay the needle end of the Infusion Set on a clean Paper Towel so that the drops will fall on the Paper Towel and will not fall onto any part of the connector (see *Figure AV*).

Note: Your Infusion Set may look different from the one illustrated here.

Note: Ensure that the site connector remains on the clean paper towel while priming.

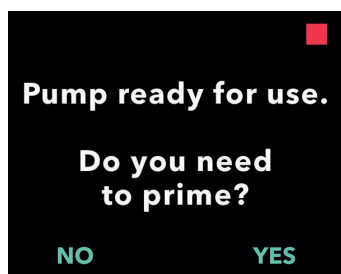

2. Start the priming process.

- a. Press YES.

Note: If the Tubing is new, you need to prime it.

Note: Pressing NO will return you to the "Start Pump" Screen.

Note: If you need to prime and you are not seeing this screen, from the status screen select "MENU", scroll to and select "Change Supplies", and then scroll to and select "Prime Infusion Line."

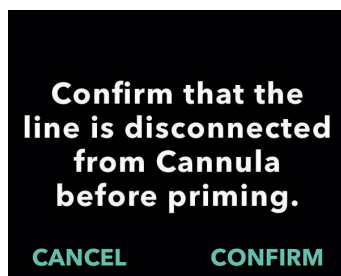

3. Confirm the Infusion Line is NOT connected to the Cannula.

- a. Press CONFIRM.

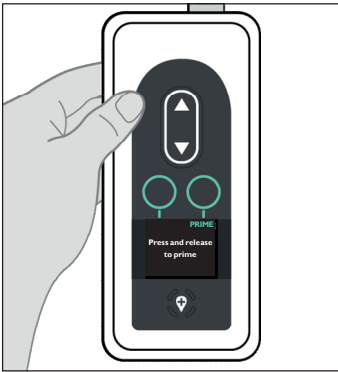

Figure AW

**Hold pump
with syringe tip
straight up**



PRIME

**Press and release
to prime**

4. Prime the Infusion Set.

- a. Hold the Pump with the Syringe tip straight up (see *Figure AW*).

Note: The Display will rotate so that you can read it when the Pump is held this way for priming.

- b. Press PRIME.

Note: The Pump must be pointing straight up and not tilted or the option PRIME will not appear. Make sure the Pump is not tilted.

Note: If the Pump is tilted slightly, the display will indicate the Syringe tip must point straight up in order to be able to prime.

Note: Each time you press PRIME, the Pump will deliver a volume of Solution into the infusion set and stop. (Continue on next page.)

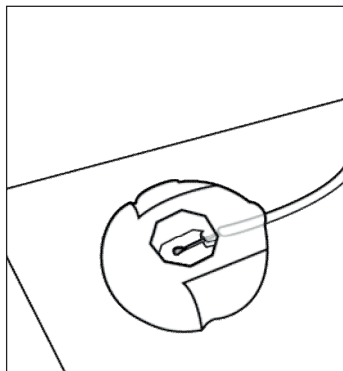

Figure AX

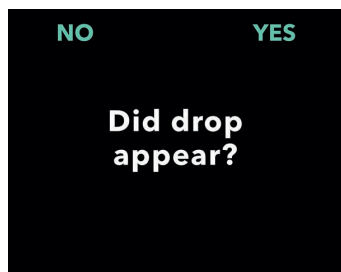
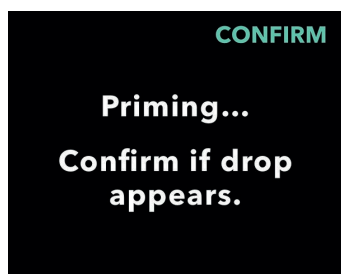

Figure AY

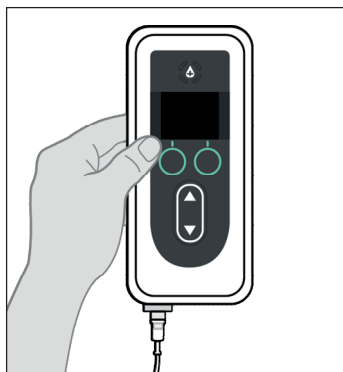

Figure AZ

5. Look for a drop of PRODUODOPA™ on the site connector needle (see *Figure AX*).

- a. Press CONFIRM when you see a drop of PRODUODOPA™ on the site connector needle.
- b. Press YES to confirm the appearance of the drop.

Note: It may take several seconds for the drop to appear.

Note: If CONFIRM is not pressed, you will be asked if a drop appeared (see *Figure AY*).

Note: Pressing NO will return you to the "Press and release to prime" screen, allowing you to continue priming until a drop appears.

6. Return the Pump to its original orientation (see *Figure AZ*) and place flat on the table.

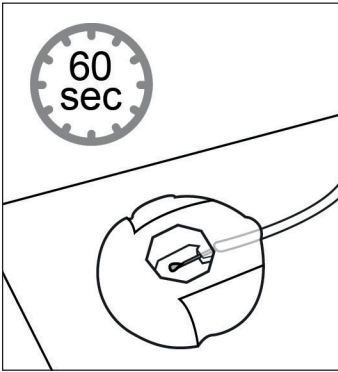

Figure BA

7. Wait at least 60 seconds to ensure that the PRODUODOPA™ has stopped dripping from the needle (see *Figure BA*).

Note: You MUST wait at least 60 seconds for the dripping to stop.

Note: Ensure that the site connector remains on the clean paper towel while priming.

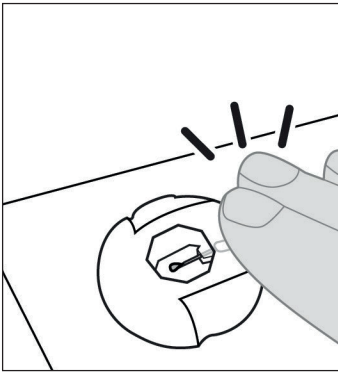

Figure BB

8. Without lifting the connector from the paper towel, tap the site connector with your finger so that any drops break free from the needle tip (see *Figure BB*).

Note: Before attaching the connector to the Cannula, make sure it is free of drops or it may later be difficult to detach from the Cannula.

Note: Some infusion sets come with protective caps, allowing you to recap the site connector and recap the Cannula until it is time to connect them.

7.9 Insert Cannula into the Body

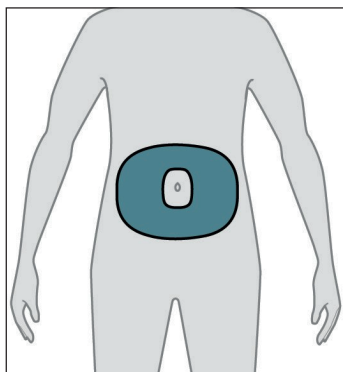

Figure BC

1. Select your desired infusion site.

Note: The following instructions describe how to insert the Cannula into your abdomen. In some cases, your Healthcare Professional may recommend inserting the Cannula into another part of your body.

- a. Choose an area (see Figure BC) at least 2 inches (5 cm) from the belly button and at least 1 inch (2.5 cm) from the previous insertion site. Change the infusion site every time you change the Infusion Set, trying not to repeat the last used site for at least 12 days.

Note: Keep at least 2 inches (5 cm) from the site of any areas of scarred or hardened tissue, stretch marks, skin folds or creases where the body naturally bends (e.g., while sitting or exercising), or to areas where clothing might cause irritation (e.g., near the belt-line).

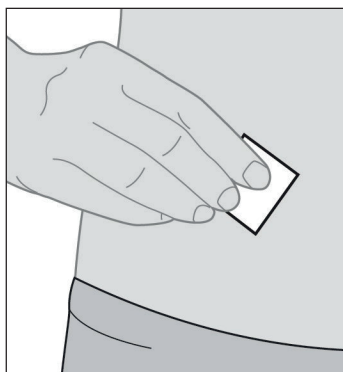

Figure BD

2. Wipe the infusion site with an Alcohol Pad (see Figure BD).

- a. Let the infusion site dry for at least 1 minute.

Note: It is important to allow it to dry fully or else the adhesive liner may not stick to the skin.



Infusion Set

3. Insert Cannula into the body ONLY.

Please refer to your ***Infusion Set Instructions For Use*** for detailed steps.

Note: After inserting the Cannula, be sure to pat down the adhesive liner to ensure it is stuck securely to the skin.

Note: After the Cannula is attached, you should check it regularly to ensure that there is no fluid leaking out on the skin. If the adhesive liner becomes loose, replace the Cannula as this may mean that the Cannula is not completely inserted under the skin.

Note: If the Infusion Set Tubing and Insertion Device/Cannula are packaged individually and you need only one of them, you can save the other for later use. If they are packaged together, the unused one must be discarded.

7.10 Connect Infusion Set Tubing to Cannula and Resume Continuous Infusion



Infusion Set

1. Connect Infusion Set Tubing to Cannula.

Please refer to your *Infusion Set Instructions For Use* for detailed steps.

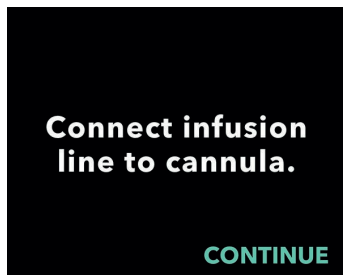

2. Confirm the Infusion Set Tubing is connected to the Cannula.

- a. Press CONTINUE.

Note: When connecting the Infusion Set Tubing to the Cannula, make sure it snaps securely in place to prevent leakage.

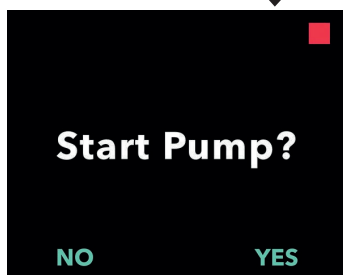

3. Start Pump.

Note: Always perform the following checks prior to starting an infusion:

1. Verify that the Infusion Set is correctly connected to the Syringe.
2. Verify that the Infusion Line has no kinks or other blockage.
3. Press YES to start the pump (the Pump will return to the Status Screen).

Note: Press NO to return to the status screen without starting the pump.

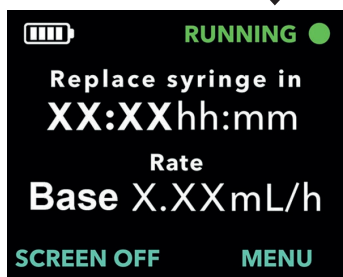

8. Troubleshooting

This section provides guidance for situations that may arise when you are using the System. In all cases, if after you have tried unsuccessfully to resolve the issue or if you are unable to correct the issue, or if you do not understand the issue, call your Healthcare Professional or call PRODUODOPA™ Support at 052-8113004.

Note: Any serious incidents that occur in relation to the device should be reported to the device manufacturer and the competent authority.

8.1 What do I do if my Syringe doesn't fit into the Pump?

If the Syringe does not fit into the Pump, it means either the Syringe Plunger Rod Pusher has not retracted or the air is not fully removed.

If the Syringe Plunger Rod Pusher isn't fully retracted, close the Lid without the Syringe in the Pump, and follow the instructions on the Pump Display, pressing the button to indicate that there is no syringe in the pump

If the Syringe does not fit into the Pump with a fully retracted Syringe Plunger Rod because there is still air in the Syringe tip, re-attach the Syringe to the Vial Adapter that is still attached to the Vial. With the Vial and Syringe pointed upward, slowly push all remaining air and a small amount of liquid back into the Vial. Then re-attach the Infusion Set Tubing and try again.

After the remaining air has been removed from the Syringe, try to load the Syringe again. Please ensure that you are using the correct Syringe, included in the list of qualified disposable components for use with the system at [devices.abbvie.com](https://www.devices.abbvie.com).

8.2 What if I accidentally indicate Tubing is primed, but I need to continue to prime?

Go to the Change Supplies MENU option on the Pump, then follow the instructions to Prime the Infusion Set Tubing.

8.3 What do I do if I need to change only my infusion set tubing and not the Cannula?

The procedure is similar to that for changing the entire infusion set, except that you must disconnect the Infusion Set Tubing from the Cannula, since you are not replacing the Cannula.

1. Stop the Pump.
2. Disconnect the old infusion set tubing from the Syringe and Cannula.
3. Discard the old Tubing.
4. Connect the new tubing to the Syringe.
5. Prime the tubing (Navigate to "Change Supplies" and select option "Prime Infusion Line").
6. Wait 60 seconds and tap away residual drips.
7. Connect primed tubing to the Cannula.
8. Start the Pump.

Note: If the Infusion Set Tubing and Insertion Device/Cannula are packaged individually and you need only one of them, you can save the other for later use. If they are packaged together, the unused one must be discarded.

8.4 What if I cannot loosen the Tubing from Syringe during Syringe replacement?

Sometimes the Tubing connector is overtightened and/or sticky when attached to the Syringe and it is difficult to remove. Try holding a warm, damp cloth in your hand to help protect your fingers from the sharp edges of the connector and try to unscrew it. If that does not work right away, let the dampness of the cloth soak in and try again. If you are still unable to loosen the tubing from the Syringe, you will need to replace your infusion set.

Note: **Do NOT** use a tool to loosen the tubing connector because it could damage the plastic part of the connector.

8.5 What if I am having trouble transferring PRODUODOPA™ from the Vial to the Syringe?

The following suggestions may assist you as you follow the Preparing Solution IFU and the IFU provided by the Vial Adapter manufacturer.

1. Ensure that the Vial Adapter spike is centered on the rubber stopper on the top of the Solution Vial before you apply a downward force.
2. Press vertically downward until the Vial Adapter snaps snugly into place onto the Vial.

8.6 What if my fully-charged Battery lasts less than 24 hours?

If a fully-charged Battery no longer enables use for at least 24 hours under normal use (64.4 °F to 82.4 °F, 18 °C to 28 °C), you may need a replacement Battery. When the Pump is operated at temperatures below 64.4 °F (18 °C) or above 82.4 °F (28 °C), the Battery will have reduced capacity.

Only use a fully charged Battery, Model RRC1120-PM, provided by the VYAFUSER™ Pump supplier.

8.7 What if I install a fully-charged Battery and the pump doesn't power on?

First, confirm that the fully-charged Battery is fully inserted and that the metal contacts on the Battery line up with the metal contacts in the pump (refer to the Figures in the section **Install Battery**). If the Battery is properly inserted and the pump isn't powering on, remove the Battery and inspect the contacts on the Battery and pump. If there is contaminant or something else blocking contact between the Battery and pump contacts, attempt to remove it. If the contacts appear to require cleaning, follow the procedure described in the section **Instructions for cleaning Battery contacts (if needed)**.

8.8 Instructions for cleaning Battery contacts (if needed).

- a. Ensure the Battery is removed.
- b. Dip the cotton swab in isopropyl alcohol (no other cleaning agent is acceptable).
- c. Depress the cotton swab against the inside of the container to remove most of the alcohol.
- d. Wipe back-and-forth with the swab against the contaminant on either the Battery contact or pump contacts.
- e. Allow the contacts to fully dry before inserting Battery.

If the Battery is properly seated and you've attempted to remove any visible contaminant and the pump is still not powering on, contact the Healthcare Professional.

8.9 What should I do if the Pump screen is blank or does not respond to any of my button pushes?

If the Pump is not responsive or the display screen remains blank after button pushes, replace the Battery with a fully charged Battery. If the Pump still does not respond, remove the Battery and wait for 10 minutes. After 10 minutes, insert the fully charged battery. If the Pump still does not respond, contact your Healthcare Professional.

8.10 What should I do if my Cannula becomes detached from my body after I have been using it?

If the Cannula becomes loose or detached from the body, you will need to replace the entire Infusion Set, including the Tubing and the Cannula. Refer to the section of the instructions ***Replace Infusion Set Tubing and Cannula (not Syringe)***.

8.11 What if I cannot remove the site connector from the Cannula during temporary disconnect?

- a. Apply a warm, soaking wet, cloth to the site connector for at least 2 minutes (to dissolve any dried PRODUODOPA™ that may be in the connector).

Note: It may help to gently squeeze the wash cloth and/or gently rub the site connector in a circular motion a few times to help the water penetrate the connector.

- b. Attempt to detach the site connector from the Cannula and lay it flat on a clean paper towel. Ensure the site connector needle is exposed so that you can inspect for a drop of PRODUODOPA™. Tap the site connector with your finger so that any drops break free from the needle tip.
- c. If you are NOT able to detach the site connector, re-soak the cloth and reapply it to the site connector for another 2 minutes. Repeat this step as many times as necessary until the site connector can be detached from the Cannula.

Note: After you have disconnected the site connector, there may still be some dried PRODUODOPA™ on the connector which may make it difficult to open on subsequent attempts.

- d. If you are unable to detach the site connector from the Cannula after multiple attempts, you will need to remove and discard the Cannula and Infusion Set Tubing (see ***Replace Infusion Set Tubing and Cannula (not Syringe)***).

8.12 What should I do if the system is leaking or if the Tubing is blocked?

If your Tubing is leaking where it is connected to the Syringe, ensure the connection is tight enough and secured. If the Tubing is damaged or blocked, or if it is leaking from the Tubing or Cannula, replace the Infusion Set, including the Tubing and Cannula. Refer to the section of the instructions ***Replace Infusion Set Tubing and Cannula (not Syringe)***.

8.13 What should I do if my Pump gets wet?

If the Pump gets wet, dry it off with a towel. If you accidentally drop the Pump and it is submerged, call your Healthcare Professional.

8.14 What should I do if I spill PRODUODOPA™?

If you spill PRODUODOPA™ on a table or on your skin, use a damp cloth and wipe it off. If you spill it on your clothing, you can blot it dry or let it dry on its own. Or you can remove the clothing and wash it using water and laundry detergent.





8.15 What if I need to stop using the Pump for an extended period of time?

If you want to stop using the Pump and want to power it off completely, stop the Pump, remove the Battery, and replace the Battery cover.

9. Alarms and Informational Messages

9.1 Alarm Overview

This section introduces the Alarms and Informational Messages that may appear on the Pump Display, along with the corrective actions. In all cases, if you are unable to correct the issue, or if you do not understand the issue, call your Healthcare Professional. The alarms and informational message screens are differentiated visually by the icon at the top of the screen and described below.

Icon	What it indicated	Action to be taken
	High priority alarm with audible tones (red)	The Pump has stopped. Take action to resolve
	Low priority alarm with audible tones (yellow)	The Pump is running. If action is not taken as indicated in the alarm message, it may lead to a high priority alarm
	Informational message with audible tones.	Provides status information
	Alarm is silenced for 1 minute	Resolve the alarm by following the corrective action or acknowledge the alarm by pressing "OK".

The actions that can be taken in response to the alarms are described in the table below.

User intent	User action	System response
Mute alarm	Press any button but 'OK'	Audible alarm is temporarily silenced, alarm icon remains on Pump display
Acknowledge alarm	Press 'OK'	Audible alarm is silenced, alarm icon disappears from Pump display. Alarm will reoccur if the problem is not fixed
Resolve alarm	Perform corrective action as described in next section	Alarm is resolved. System is ready to resume therapy



The Pump's audible alarms will continue to sound until they are acknowledged by pressing the OK button. To temporarily mute an alarm sound, press any button other than OK. When muted, an icon will remain on the screen. If the alarm is muted and not acknowledged, the audible signal will resume after 1 minute. To acknowledge an alarm press OK. When acknowledged, the alarm sound will stop.

The tables on the following pages list all alarms and informational messages. The first table (High and Low Priority Alarms) contains in alphabetical order, High Priority Alarms (red caution symbol) and Low Priority Alarms (yellow caution symbol).

The second table (Informational Messages) contains status information and guidance in alphabetical order. Informational messages, displayed with an "i" at the top, provide status information but are not alarms. They appear when the user attempts an action that is not available (e.g., Extra Dose not enabled) and a notification when a Pump action is completed (e.g., Loading Dose delivery complete).

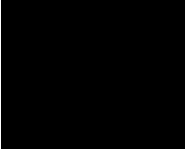
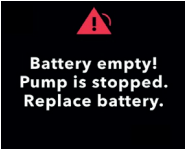
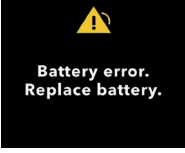
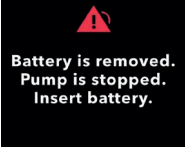

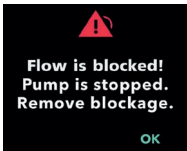
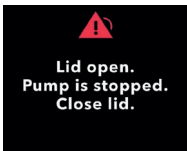
9.2 High and Low Priority Alarms (listed alphabetically)

Display	Description	Acoustic Signal	Corrective Action
	The screen remains blank and the Pump does not respond to any button pushes.	None	If the Pump is not responsive and the display screen remains blank, replace the Battery with a fully charged Battery. If the Pump still does not respond, remove the Battery and wait for 10 minutes. After 10 minutes, insert the fully charged Battery. If the Pump still does not respond, contact your Healthcare Professional.
	Battery is empty. Pump has stopped. Battery needs to be replaced now.	3 tones, short pause, 2 tones, repeat	Replace the Battery with fully charged Battery Model RRC1120-PM, provided by the VYAFUSER™ Pump supplier.
	Battery Error. Replace Battery.	2 tones	Replace the Battery with a fully charged Battery Model RRC1120-PM, provided by the VYAFUSER™ Pump supplier.
	Battery is removed. Pump is stopped.	3 tones, short pause, 2 tones, repeat	If the Battery is in the Pump, remove it, wait for blank screen, and re-insert it. If that does not work, replace the Battery.

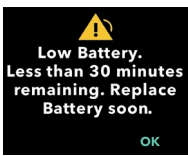
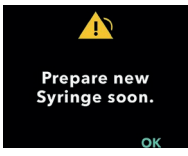
Display	Description	Acoustic Signal	Corrective Action
 <p>Flow is blocked! Pump is stopped. Remove blockage. OK</p>	<p>There is a blockage in the fluid path preventing PRO-DUODOPA™ from being administered.</p> <p>Pump has stopped.</p>	<p>3 tones, short pause, 2 tones, repeat</p>	<p>Remove the blockage. Inspect the Tubing for kinks that could be stopping the flow of PRODUODOPA™. Open the Pump lid and ensure that there is nothing in the Syringe housing that is obstructing the Syringe. If problem continues, replace Infusion Set Tubing and Cannula.</p> <p>If blockage is found in the Tubing, Troubleshooting section "<i>What do I do if I need to change only my infusion set tubing and not the Cannula?</i>"</p>
 <p>Lid open. Pump is stopped. Close lid.</p>	<p>Lid has been opened.</p> <p>Pump has stopped delivering PRO-DUODOPA™.</p> <p>Close Lid.</p>	<p>3 tones, short pause, 2 tones, repeat</p>	<p>Close the Lid to continue receiving therapy. If the Lid is properly closed and this alarm continues, contact your Healthcare Professional.</p>
 <p>Low battery. Less than 4 hours remaining. OK</p>	<p>Battery is low.</p> <p>Pump will stop within 4 hours.</p> <p>Have charged Battery ready.</p>	<p>2 tones</p>	<p>Make sure you have a fully charged Battery ready.</p>

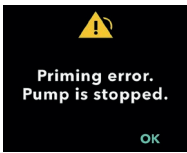
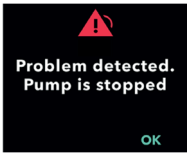
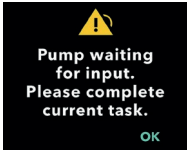
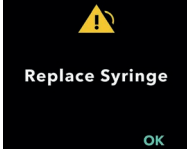
Display	Description	Acoustic Signal	Corrective Action
 <p>Low Battery. Less than 30 minutes remaining. Replace Battery soon.</p> <p>OK</p>	<p>Battery is low. Battery will be depleted and Pump will stop within 30 minutes.</p> <p>When running faster rates and when operating the Pump in cold weather, the Battery will deplete more quickly.</p> <p>Replace the Battery as soon as possible.</p>	<p>2 tones</p>	<p>Replace the Battery with a fully charged Battery or make sure you have a fully charged Battery ready (see section <i>Maintenance: Replace Battery</i>).</p>
 <p>Prepare new Syringe soon.</p> <p>OK</p>	<p>The Syringe has been in the Pump for 23 hours. The Syringe is intended to be discarded 24 hours from when the PRO-DUODOPA™ was transferred to the Syringe. Prepare a new Syringe soon.</p>	<p>2 tones</p>	<p>While the therapy is still running, if refrigerated prior to use, remove a new Solution Vial from the refrigerator. Allow it to warm at room temperature for 30 minutes, and then transfer the PRODUODOPA™ to the Syringe as described in the <i>Preparing Solution Instructions for Use</i>.</p>

Display	Description	Acoustic Signal	Corrective Action
 <p>Priming error. Pump is stopped. OK</p>	The Pump is not priming as expected and the tubing is not primed.	2 tones	Inspect to see if the Syringe is leaking where the Tubing connects to the Syringe. If it is leaking, wipe it clean, tighten the connection, and prime again. If there is no leak, repeat priming until the air is removed.
 <p>Problem detected. Pump is stopped. OK</p>	Pump has detected a problem and is not delivering PRO-DUODOPA™.	3 tones, short pause, 2 tones, repeat	Press OK and follow instructions on screen to reset Pump. You may need to do this more than once. If the problem persists, contact your Healthcare Professional. Ensure you are using a fully charged Battery.
 <p>Pump waiting for input. Please complete current task. OK</p>	Pump is waiting for input. Please complete current task.	2 tones	The Pump needs additional input from you to continue. Press OK to continue with current task.
 <p>Replace Syringe OK</p>	The Syringe has been in the Pump for 24 hours. The Syringe is intended to be discarded after 24 hours.	2 tones	Replace the current Syringe with a new Syringe within 1 hour of first notification. Refer to Preparing Solution Instructions for Use.



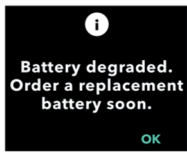
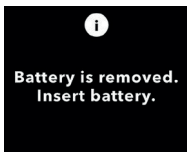
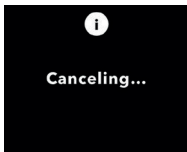
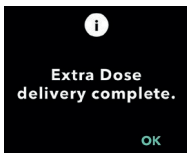

Display	Description	Acoustic Signal	Corrective Action
 <p data-bbox="153 245 302 302">Syringe is empty! Pump is stopped. Replace Syringe.</p> <p data-bbox="270 321 291 337">OK</p>	<p data-bbox="348 191 469 248">Syringe is empty.</p> <p data-bbox="348 264 469 326">Pump has stopped.</p> <p data-bbox="348 342 533 464">Replace the current Syringe with a new Syringe.</p>	<p data-bbox="568 191 663 345">3 tones, short pause, 2 tones, repeat</p>	<p data-bbox="738 191 979 345">Replace the Syringe immediately with a new Syringe (see section Replace Syringe).</p>
 <p data-bbox="163 537 291 594">Syringe will be empty within 45 minutes.</p> <p data-bbox="270 613 291 630">OK</p>	<p data-bbox="348 483 533 638">At the current Rate, the Syringe will be empty within 45 minutes.</p>	<p data-bbox="568 483 653 508">2 tones</p>	<p data-bbox="738 483 963 670">While the therapy is still running, if refrigerated prior to use, remove a new Solution Vial from the refrigerator.</p> <p data-bbox="738 670 953 857">Allow it to warm at room temperature for 30 minutes, and then transfer the PRO-DUODOPA™</p> <p data-bbox="738 857 979 1011">to the Syringe as described in the Preparing Solution Instructions for Use.</p>
 <p data-bbox="163 1081 291 1138">Syringe will be empty within 2 hours.</p> <p data-bbox="270 1157 291 1174">OK</p>	<p data-bbox="348 1027 522 1182">At the current Rate, the Syringe will be empty within 2 hours.</p>	<p data-bbox="568 1027 653 1052">2 tones</p>	<p data-bbox="738 1027 969 1117">Remember to get a new Syringe ready soon.</p>

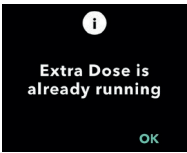
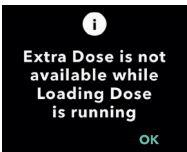
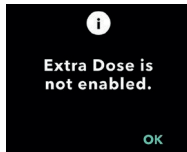
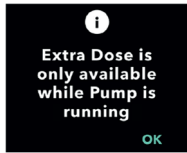
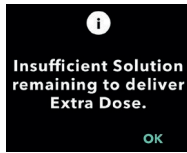

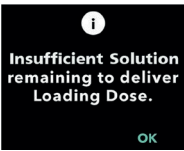
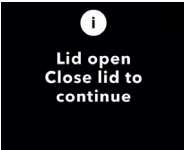
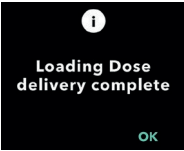
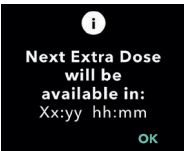
9.3 Informational Messages

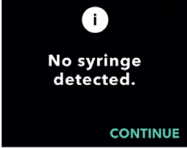
Display	Description	Acoustic Signal	Corrective Action (if applicable)
 <p>Battery degraded. Order a replacement battery soon. OK</p>	It is possible that the Battery is not keeping a charge as expected.	2 Beeps	It is possible that the Battery contacts need cleaning. Refer to Troubleshooting section of this IFU "What if I install a fully-charged Battery and the pump doesn't power on?" Also, refer to the "Instructions for cleaning Battery contacts (if needed)." If this does not work, replace the Battery with a fully charged Battery, Model RRC1120-PM, provided by the VYAFUSER™ Pump supplier.
 <p>Battery is removed. Insert battery.</p>	Battery is removed.	2 Beeps	If the Battery is in the Pump, remove it, wait for blank screen, and re-insert it. If that does not work, replace the Battery.
 <p>Canceling...</p>	Action has been canceled.	2 Beeps	N/A
 <p>Extra Dose delivery complete. OK</p>	Extra Dose delivery has been completed.	2 Beeps	Press OK to continue.

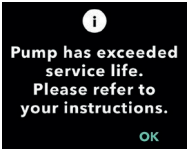
Display	Description	Acoustic Signal	Corrective Action (if applicable)
	User tries to administer an Extra Dose while another Extra Dose is being administered.	2 Beeps	Allow the Extra Dose to complete its administration. Press OK to continue.
	Extra Dose cannot be administered while Loading Dose is running.	2 Beeps	Wait until the Loading Dose has finished before administering Extra Dose.
	Extra Dose has not been enabled on your Pump.	2 Beeps	Press OK to continue.
	Extra Doses can only be administered while the Pump is running.	2 Beeps	Start the Pump and then deliver the Extra Dose.
	Not enough PRO-DUODOPA™ remaining in the Syringe to deliver the Extra Dose. Syringe needs to be changed.	2 Beeps	While the therapy is still running, prepare a new replacement Syringe. If refrigerated prior to use, remove a new Solution Vial from the refrigerator. Allow it to warm at room temperature for 30 minutes, and then transfer the PRODUODOPA™ to the Syringe as described in the Preparing Solution Instructions for Use .

Display	Description	Acoustic Signal	Corrective Action (if applicable)
	<p>Not enough PRODUODOPA™ remaining in the Syringe to deliver the Loading Dose.</p> <p>Syringe needs to be changed.</p>	2 Beeps	Change the Syringe as described in Replace the Syringe .
	The lid has been opened.	2 Beeps	Close the Lid and follow the display screen prompts to acknowledge whether the Syringe was inserted or removed.
	Loading Dose delivery is complete.	2 Beeps	Press OK to continue.
	Extra Dose is locked out for XX hours and YY minutes.	2 Beeps	Note how much time must elapse until the Lockout Time has expired and you are able to administer the next Extra Dose. Press OK to continue.

Display	Description	Acoustic Signal	Corrective Action (if applicable)
	<p>The Pump has not detected that a Syringe is in the Pump.</p>	<p>2 Beeps</p>	<p>If a Syringe is in the Pump, open the lid and ensure the Syringe is seated correctly. If there is no Syringe in the Pump, insert a Syringe.</p>
	<p>Pump is disabled due to a Pump failure. Problem cannot be resolved by replacing the Battery.</p>	<p>2 Beeps</p>	<p>Contact the Healthcare Professional.</p>
	<p>Pump has exceeded service life. Please refer to your instructions.</p>	<p>2 Beeps</p>	<p>Although the Pump will continue to operate, it has reached the end of its designed life and should be replaced as soon as possible. Contact your Healthcare Professional.</p>
	<p>Pump is tilted during priming. Point Syringe straight up to continue with priming.</p>	<p>2 Beeps</p>	<p>Reposition the Pump so the Syringe tip point is straight up.</p>

Display	Description	Acoustic Signal	Corrective Action (if applicable)
 <p data-bbox="93 235 271 308">Remove battery. Await blank screen. Re-insert battery. Refer to instructions.</p>	<p data-bbox="300 186 473 243">Problem is not resolved.</p>	<p data-bbox="519 186 617 211">2 Beeps</p>	<p data-bbox="661 186 920 1031">Remove the Battery and wait until the screen goes blank. After the screen has gone blank, re-insert the Battery, taking care not to press any of the Pump buttons. Wait for the Pump to re-start. If the problem is corrected, you must then replace the Syringe with a new Syringe. Otherwise the Pump clock will reset "Replace Syringe in" to 24 hours and you may not receive the "Replace Syringe Alarm" when the Syringe has been in the Pump for 24 hours. If the problem persists, contact the Healthcare Professional.</p>
 <p data-bbox="122 1096 239 1136">Syringe error. Please wait.</p>	<p data-bbox="300 1047 462 1201">The Pump is not able to detect if a Syringe is loaded or not.</p>	<p data-bbox="519 1047 617 1071">2 Beeps</p>	<p data-bbox="661 1047 920 1234">Wait for the Pump to return to the Status Screen. Navigate to "Insert Syringe" and follow the instructions on the screen.</p>

10. Device Information

10.1 Last 3 Alarms

Note: In some cases your Healthcare Professional may ask you to review the most recent alarms that have appeared on your display.

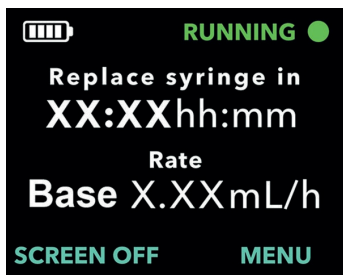

1. Turn on the Pump Display if needed.

- Press any button (Arrow Keys or Selection Buttons).
- Press MENU to display the Pump Menu options.

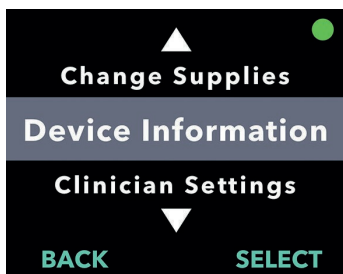

2. Use the Arrow Keys to scroll to and highlight the *Device Information* menu option.

- Press SELECT to choose the option to view the *Device Information*.

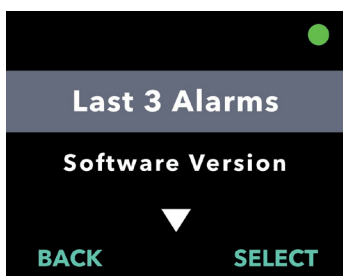

3. Use the Arrow Keys to highlight the *Last 3 Alarms* menu option.

- Press SELECT to choose the option to *Last 3 Alarms* and then follow the instructions on the Display.

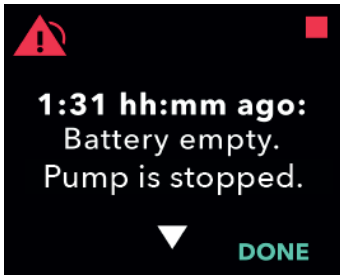

4. Review the recent alarms.

- a. The Pump is able to display the last 3 high priority alarms that have occurred. Using the up and down arrows you can scroll through them.

Note: The first alarm displayed will be the most recent alarm that occurred.

Note: At 24 hours, the display will change from hh:mm (hours:minutes) to d:hh (days:hours). At 10 days, the display will change to ddd (days) ago.

Note: The Pump run status in the upper right corner indicates if the Pump is running when this screen is displayed. When the actual high priority alarm is issued, the Pump will not be running.

10.2 Software Version

Displays the version of software on the Pump.

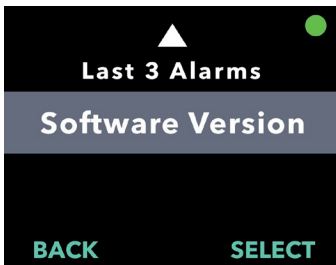

1. Use the Arrow Keys to highlight the *Software Version* menu option.

- a. Press SELECT.



11. Maintenance

11.1 Replace Battery

Note: Always stop any delivery in progress prior to replacing the Battery.

Note: Replace your Battery with a fully charged Battery every day at the same time as part of your daily routine. Always charge the used Battery immediately after removing it from the Pump. This will ensure that you have a fully charged spare Battery available at all times. Only use a fully charged Battery, Model RRC1120-PM, provided by the VYAFUSER™ Pump supplier.

Note: If the Pump will be stored for longer than 1 week, remove the Battery from the Pump and fully charge all Batteries before storing. Failure to do so could affect future operation of the Battery.

Note: If your fully charged Battery does not last as long as you expect, see **Troubleshooting: What if my fully charged Battery lasts less than 24 hours?**

Note: If you change both your Syringe and Battery at the same time, it is recommended that you remove and replace the Battery while the Syringe is in the Pump. This will shorten the time it takes for the Pump to reset.

Note: After removing the old Battery, insert the new Battery into the Pump right away. If too much time elapses between removing the old Battery and inserting the new Battery, the Pump screen may display the "Insert Syringe" menu option rather than "Start Pump." If this occurs, you must then replace the Syringe with a new Syringe. Otherwise the Pump clock will reset "Replace Syringe in" to 24 hours and you may not receive the "Replace Syringe Alarm" when the Syringe has been in the Pump for 24 hours.

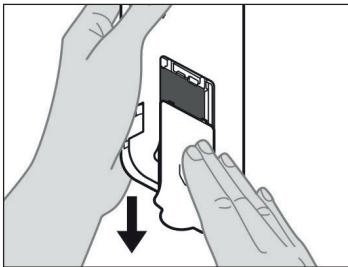

Figure BE

1. Stop the Pump.
2. Remove the Battery Cover from the Pump (see Figure BE).

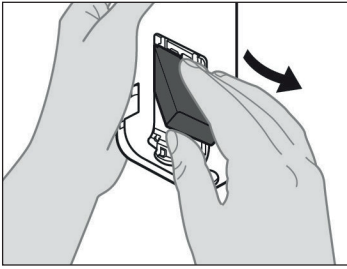

Figure BF

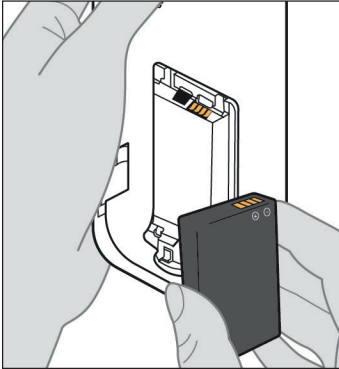

Figure BG

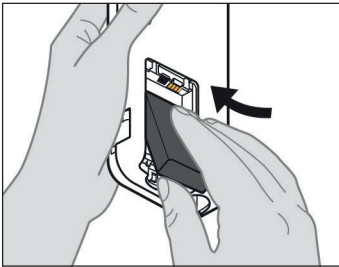

Figure BH

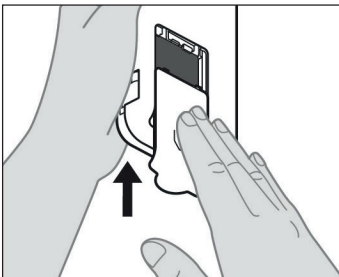

Figure BI

Remove the used Battery (see *Figure BF*).

4. Insert Battery into the Battery compartment.

Note: Use only a fully charged Battery, Model RRC1120-PM, provided by the VYAFUSER™ Pump supplier.

- a. Match the metal contacts of the Battery and Battery compartment (see *Figure BG*).
- b. With the metal contact end inserted first, slide the Battery into the compartment (see *Figure BH*).

Note: You will hear a “click” when the Battery is in place.

5. Slide the Battery Cover onto the Pump (see *Figure BI*).



Battery Charger

6. Insert the used Battery into the Battery Charger to begin the charging process.

Please refer to your **Battery Charger Instructions For Use** for detailed steps.

Preparing for use.
Please wait...

7. After inserting the new Battery, the Pump will run power on self tests.

Please wait.



8. After inserting the Battery, wash your hands with soap and water and dry them.

Preparing for use.
Please wait...



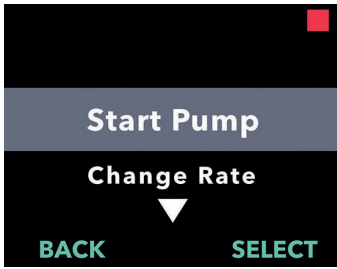

9. Choose the Start Pump menu option.
 - a. Press SELECT.

11.2 Cleaning the Pump, Mains Adapter and Charger

It is recommended that you clean the external, non-electrical surfaces of the Pump, mains adapter or charger, as needed. To clean any of them, use a soft cloth lightly dampened only with clean water and mild detergent or with diluted household bleach (1 part bleach to 9 parts water). Gently wipe the exterior surfaces of these components as needed (including those of the pump that are exposed when the lid is open).

Note: If you are cleaning the mains adapter or charger, ensure the mains adapter is unplugged.

Note: Keep Battery door closed while cleaning.

Note: Allow Components to dry completely before use. You may dry them with a soft cotton cloth.

Note: Avoid spillage of liquids onto, or into, the Pump. If the Pump gets wet, immediately attempt to dry it with clean absorbent paper towels.

12. Technical Specifications

12.1 Battery Service Life

A Battery is expected to last for 2 years under typical use conditions. If a fully-charged Battery no longer enables use for at least 24 hours under normal use (64.4 °F to 82.4 °F, 18 °C to 28 °C), you may need a replacement Battery. When the Pump is operated at temperatures below 64.4 °F (18 °C) or above 82.4 °F (28 °C), the Battery will have reduced capacity.

12.2 MRI Safety Information

The VYAFUSER™ Pump is MR Unsafe.

The Pump presents a projectile hazard in MR environments.

12.3 Electromagnetic Compatibility

The electromagnetic compatibility tests were performed in compliance with the standards:

- IEC 60601-2-24:2012, Medical electrical equipment, Part 2: Particular requirements for the safety of infusion Pumps and controllers;
- IEC 60601-1-2 Ed. 4:2014, Medical electrical equipment, Part 1: General requirements for basic safety and essential performance – collateral standard: Electromagnetic compatibility – Requirements and tests.

Guidance and Manufacturer's Declaration – Electromagnetic Emissions		
The Pump with Battery is suitable for use in the electromagnetic environment specified below. The user of the Pump with Battery should assure that it is used in such an environment.		
Emissions Test	Compliance	Electromagnetic Environment – Guidance
RF emissions: CISPR 11	Group 1	The Pump with Battery uses RF energy only for its internal function. Therefore, its RF emissions are very low and are not likely to cause any interference in nearby electronic equipment.
RF emissions CISPR 11	Class B	The Pump with Battery is intended for use in all establishments including domestic establishments and those directly connected to the public low-voltage power supply network that supplies buildings used for domestic purposes.
Harmonic emissions IEC 61000-3-2	Not Applicable	
Voltage fluctuations/ flicker emissions IEC 61000-3-3	Not Applicable	

IMMUNITY to proximity fields from RF wireless communications equipment:

As per the use environment, the pump can come into close proximity with other RF wireless communication equipment like mobile phones. Accordingly, the test levels were increased considering the minimum distance of 3.1 inches (8 cm) using the below equation.

$$E = (6/d) * \sqrt{P}$$

Where P is the maximum power in W, d is the minimum separation distance in m, and E is the IMMUNITY TEST LEVEL in V/m.

Guidance and Manufacturer's Declaration – Electromagnetic Immunity			
The Pump with Battery is intended for use in the electromagnetic environment specified below. The user of the Pump with Battery should assure that it is used in such an environment.			
Immunity Test	IEC 60601 Test Level	Compliance Level	Electromagnetic Environment – Guidance
Electrostatic discharge (ESD) IEC 61000-4-2	± 8 kV contact ± 2, 4, 8, 15 kV air	± 8 kV contact ± 2, 4, 8, 15 kV air	Floors should be wood, concrete, or ceramic tile. If floors are covered with synthetic material, the relative humidity should be at least 30%. Pump may reset at 15 kV, but it is ensured that pump is safe by completing POST sequence.
Surge IEC 61000-4-5	± 1 kV line(s) to line(s) ± 2 kV line(s) to earth	Not Applicable Not Applicable	Not Applicable, the Pump can only be powered from a Battery. Not Applicable, the Pump can only be powered from a Battery.
Voltage dips, short interruptions and voltage variations on power supply input lines IEC 61000-4-11	0 % UT; 0.5 cycle at 0°, 45°, 90°, 135°, 180°, 225°, 270°, and 315°	Not Applicable	Not Applicable, the Pump can only be powered from a Battery.











Power frequency (50/60 Hz) magnetic field IEC 61000-4-8	30 A/m, 50 Hz or 60 Hz	100 A/m, 50/60 Hz	If image distortion occurs, it may be necessary to position the Pump with Battery further from sources of power frequency magnetic fields or to install magnetic shielding. The power frequency magnetic field should be measured in the intended installation location to assure that it is sufficiently low.
Immunity Test	IEC 60601 Test Level	Compliance Level	Electromagnetic Environment – Guidance
Conducted RF IEC 61000-4-6	3 Vrms on 150 kHz to 80 MHz 1 kHz 80% AM modulation 6 Vrms in ISM bands	3 Vrms on 150 kHz to 80 MHz 1 kHz 80% AM modulation 6 Vrms in ISM bands	Refer to table "Test levels for Proximity fields from RF wireless communications equipment" related to immunity of the pump from portable and mobile RF communications equipment.
Radiated RF IEC61000-4-3	10 V/m 80 MHz – 2.7 GHz 80 % AM at 1 kHz	10V/m	





Test levels for Proximity fields from RF wireless communications equipment						
Test Frequency MHz	Band MHz	Service	Modulation	Maximum Power (W)	Distance (m)	Compliance test level (V/m)
385	380-390	TETRA 400	Pulse modulation 18 Hz	1.8	0.08	101
450	430-470	GMRS 460, FRS 460	FM ± 5 kHz deviation 1 kHz sine wave	2	0.08	106
710	704-787	LTE Band 13, 17	Pulse modulation 217 Hz	0.2	0.08	34
745						
780						
810	800-960	GSM 800/900, TETRA 800, iDEN 820, CDMA 850, LTE Band 5	Pulse modulation 18 Hz	2	0.08	106
870						
930						
1720	1700-1990	GSM 1800; CDMA 1900; GSM 1900; DECT; LTE Band 1, 3, 4, 25; UMTS	Pulse modulation 217 Hz	2	0.08	106
1845						
1970						





2450	2400-2570	Bluetooth, WLAN, 802.11 b/g/n, RFID 2450, LTE Band 7	Pulse modulation 217 Hz	2	0.08	106
5240	5100-5800	WLAN 802.11 a/n	Pulse modulation 217 Hz	0.2	0.08	34
5500						
5785						
<p>The test frequency step was 5 MHz (e.g., 704-787 MHz range was measured from 705-785 MHz using 5 MHz steps)</p> <p>As an alternative to FM modulation, 50% pulse modulation at 18 Hz was chosen at 450 MHz test frequency</p> <p>Additional test was performed at 3.5 GHz (WiMAX) and test level of 106 V/m (considering 0.08 m separation distance)</p>						

13. Reference

13.1 Explanation of Symbols

Symbol	Title and Designation Number of Standard Regulation or Guidance	Reference Number	Title/Meaning of Symbol
	EN ISO 7010:2020 ISO 7010: 2019	ISO 7010- W001	General Warning Sign
	EN ISO 15223-1:2021 ISO 15223-1:2021	5.1.1	Manufacturer
	EN ISO 15223-1:2021 ISO 15223-1:2021	5.1.3	Date of Manufacture
	EN ISO 15223-1:2021 ISO 15223-1:2021	5.1.5	Batch Code
	EN ISO 15223-1:2021 ISO 15223-1:2021	5.1.6	Catalog Number
	EN ISO 15223-1:2021 ISO 15223-1:2021	5.1.7	Serial Numbers
	EN ISO 15223-1:2021 ISO 15223-1:2021	5.3.4	Keep Dry
	EN ISO 15223-1:2021 ISO 15223-1:2021	5.3.7	Temperature Limits
	EN ISO 15223-1:2021 ISO 15223-1:2021	5.3.8	Humidity Limits
	EN ISO 15223-1:2021 ISO 15223-1:2021	5.3.9	Atmospheric Pressure Limits
	EN ISO 15223-1:2021 ISO 15223-1:2021	5.4.12	The medical device can be used multiple times by a single patient medical device

Symbol	Title and Designation Number of Standard Regulation or Guidance	Reference Number	Title/Meaning of Symbol
	Regulation (EU) 2017/745	Annex V	CE mark, indicates that this device is in conformity with the applicable requirements set out in (EU) 2017/745 and other applicable directives and regulations.
	EN ISO 15223-1:2021 ISO 15223-1:2021	5.7.7	Medical Device
	1. ASTM F2503-20 2. Testing and Labeling Medical Devices for Safety in the Magnetic Resonance (MR) Environment, FDA Guideline May 20, 2021	1. Figure 9 2. VIII	MR Unsafe The medical device is magnetic resonance unsafe and should be kept away from magnetic resonance environments such as MRI scanner rooms.
	EN 50419:2006	Clause 4.2	WEEE (EU- directive) The product should not be discarded as unsorted waste but must be sent to separate collection facilities for recovery and recycling.

Symbol	Title and Designation Number of Standard Regulation or Guidance	Reference Number	Title/Meaning of Symbol
	EU Directive 94/62/ EC of 20 December 1994 on Packaging and Packaging Waste & EU Commission Decision 97/129/EC	20 is reserved for corrugated fiberboard (PAP- paper)	Recycling
	IATA Dangerous Goods Regulations	Figure 7.1.C	Dangerous Goods
	EN ISO 7010:2020 ISO 7010: 2019	ISO 7010- M002	Refer to instruction manual/booklet
	IEC 60417:2002 DB	IEC 60417- 5333	Type BF Applied Part
IP22	IEC 60529:2001	Clause 4.1 and 4.2	Protected against foreign objects of Ø 12.5mm and greater Protection against vertically falling water drops when ENCLOSURE tilted up to 15°
Rx only	21CFR801.109	(b) (1)	This symbol statement is used to indicate that US Federal law restricts this delivery system from being used or being sold unless it is ordered by a physician.

Symbol	Title and Designation Number of Standard Regulation or Guidance	Reference Number	Title/Meaning of Symbol
	EN ISO 15223-1:2021 ISO 15223-1:2021	5.1.4	Use by date (expiration date)*

* This symbol does not appear on and does not apply to the pump or carrying accessory labels.

References

EN ISO 15223-1:2021 Medical Devices — Symbols to be used with medical device labels, labeling, and information to be supplied — Part 1: General Requirements

ISO 15223-1:2021 Medical Devices — Symbols to be used with medical device labels, labeling, and information to be supplied — Part 1: General Requirements

EN ISO 7010:2020 Graphical symbols — Safety colours and safety signs — Registered safety signs

ISO 7010:2019 Graphical symbols — Safety colours and safety signs — Registered safety signs

IEC 60529:2001 Degrees of protection provided by enclosure (IP code)







IEC 60417:2002 DB Graphical symbols for use on equipment

Testing and Labeling Medical Devices for Safety in the Magnetic Resonance (MR) Environment, FDA Guideline May 20, 2021

21 CFR 801.109 Code of Federal Regulations Title 21 Volume 8
Sec.801.109 Prescription Devices

ASTM F2503-20 Standard Practice for Marking Medical Devices and Other Items for Safety in the Magnetic Resonance Environment

13.2 Pump Kit Labels

Symbol	Title and Designation Number of Standard Regulation or Guidance	Reference Number	Title/Meaning of Symbol
	N/A	N/A	Instruction Manual
	N/A	N/A	Charging System (mains/AC adapter and charging station)
	N/A	N/A	Charging System Note: Lift up and to the left to open
	N/A	N/A	Battery
	N/A	N/A	Pump
	N/A	N/A	Carrying Accessory
	N/A	N/A	Carrying Accessory Note: Lift up and to the right to open

13.3 Tubing, Adapters, and Accessories

The disposable components that have been qualified for use with this system can be found at: devices.abbvie.com This includes the Vial Adapter, Infusion Set (inserter, cannula and tubing), and Syringe.

14. Storage and Transport Conditions

The allowed storage and transport conditions for Pump, Battery Charging System, and Carrying Accessory include:

- -4 °F to 41 °F (-20 °C to 5 °C) with uncontrolled humidity
- 41 °F to 104 °F (5 °C to 40 °C), up to 90% relative humidity non-condensing
- 104 °F to 140 °F (40 °C to 60 °C), up to 15% relative humidity non-condensing
- Atmospheric pressures ranging from 53.3 kPa to 106 kPa, inclusive.

The System should be stored at room temperature when not in use. If the system is stored or transported at the maximum or minimum temperatures allowed for storage and transport, it requires a minimum of 30 minutes in a 20 °C environment to reach operating temperature.

**For questions or problems, call
your Healthcare Professional,
or call PRODUODOPA™
Support at 052-8113004.**

THIS PAGE IS INTENTIONALLY LEFT BLANK.