

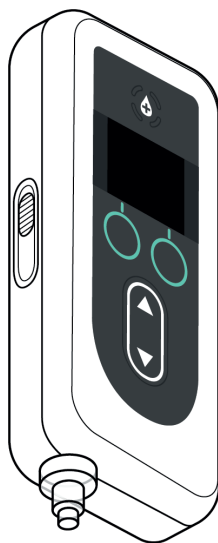

Healthcare Professional Instructions for Use of VYAFUSER™ Pump

VYAFUSER™ and DUODUOPA® SC are trademarks of AbbVie AB.



 Phillips-Modicon A/S
Gimsinglundvej 20
DK-7600 Struer
Denmark

These Instructions for Use are to be used exclusively with the DUODOPA® SC Delivery System. These Instructions for Use are to be used only by Healthcare Professionals. They are **NOT**

intended for Patients or Caregivers.



This Instruction for use is available on Phillips-Modicon website
<https://www.phillipsmodicon.com/ifu>



devices.abbvie.com

devices.abbvie.com

The DUODOPA[®] SC delivery system Instructions For Use (IFU) is composed of HCP IFU and Patient IFU. Collectively, the patient IFU and HCP IFU form the complete DUODOPA[®] SC delivery system IFU.

HCP IFU is only intended for HCP to program the pump. HCP IFU contains instructions on how to program the pump for a particular patient and the relevant technical specification. All other information related to the DUODOPA[®] SC delivery system can be found in the Patient Instructions for Use.

Patient IFU is intended to be used by advanced Parkinson's patients, their Caregivers, and HCPs. Patient Instructions for Use contains instructions on how to use the pump and accessories to deliver the drug.

Specific individual component IFUs (i.e., preparing solution IFU, carrying accessory IFU, vial adapter IFU, mains adapter IFU, battery charger IFU, and infusion set IFU) are referenced in the patient IFU.

TABLE OF CONTENTS

1. Introduction	1
1.1 Intended Use.....	1
1.2 Intended User.....	1
1.3 Indication for Use.....	1
1.4 Warnings and Cautions.....	2
1.5 Pump Components.....	4
2. Initial Setup	7
2.1 Initial Setup.....	7
2.2 Inspect Components and Install Battery.....	7
2.3 Set PIN.....	10
2.4 Set Continuous Infusion Rates.....	13
2.5 Set Extra Dose.....	15
2.6 Set Loading Dose.....	17
3. Change Therapy Settings	21
3.1 Access Clinician Settings.....	21
3.2 PIN Entry Failure.....	23
3.3 PIN Forgotten.....	24
3.4 Adjust Continuous Infusion Rates.....	25
3.5 Adjust Extra Dose.....	28
3.6 Disable Extra Dose.....	30
3.7 Adjust Loading Dose.....	32
3.8 Disable Loading Dose.....	34
4. Set Language	37
5. Change PIN	39
6. Reset PIN (Forgotten PIN)	41
7. Remove Battery	45
8. Re-packaging for Patient Use	47

9. Subcutaneous Insertion	49
<hr/>	
10. Informational Messages	51
<hr/>	
10.1 Informational Messages	51
11. Technical Specifications	53
<hr/>	
11.1 Technical Features	53
12. Reference	59
<hr/>	
12.1 Explanation of Symbols.....	59
12.2 Pump Kit Labels	63

1. Introduction

1.1 Intended Use

The DUODOPA® SC Drug Delivery System is an automated drug delivery system intended for the infusion of DUODOPA® SC to treat advanced Parkinson's disease.

The VYAFUSER™ Pump is an ambulatory infusion pump intended for the subcutaneous delivery of DUODOPA® SC.

1.2 Intended User

The DUODOPA® SC Drug Delivery System is intended to be used by adult patients with advanced Parkinson's disease, caregivers, and healthcare professionals.

The VYAFUSER™ Pump is intended to be used by adult patients with advanced Parkinson's disease, caregivers, and healthcare professionals.

1.3 Indication for Use



DUODOPA® SC is a combination of foscariodopa and foslevodopa indicated for the treatment of motor fluctuations in patients with advanced Parkinson's disease.

The VYAFUSER™ Pump is an ambulatory infusion pump indicated for the treatment of motor fluctuations in patients with advanced Parkinson's disease.

The VYAFUSER™ Pump can be operated in both clinical and non-clinical environments, including the home, outside the home, and during travel (including air travel).

1.4 Warnings and Cautions

Warnings

-  The **Healthcare Professional Instructions for Use of VYAFUSER™ Pump** is intended to be used only by a qualified Healthcare Professional trained on the use of this system.
-  Only use the Delivery System in a manner described in these Instructions for Use and after you have received training.
-  The Delivery System must only be used with disposable components that have been qualified for use with this system. Qualified components can be found at: devices.abbvie.com. This includes the Vial Adapter, Infusion Set (inserter, cannula and tubing), and Syringe. The use of unqualified components may lead to allergic reaction, infection, or improper function.

Component	Manufacturer	Description	Part Number	CE Mark Status
Vial Adapter	West Pharma Services IL, Ltd.	Vented Vial Adapter 20mm FLL-VF	8073052	Certificate Number: 3902869CE01 Notified Body / Number: DEKRA 0344
Infusion Set (inserter, cannula, and tubing)	Convatec Unomedica a/s	Neria Guard Infusion Set, 6 mm needle length, 60 cm tubing length Neria Guard Infusion Set, 9 mm needle length, 60 cm tubing length	704060-5226 704060-5229	Certificate Number: 39124 Rev. 2 Notified Body / Number: GMED 0459
Syringe	B. Braun Medical Inc.	Omnifix™ Syringe, Luer Lock 10 mL Syringe	4617100V	Certificate Number: G1 012974 0607 Rev. 02 Notified Body / Number: TÜV SÜD 0123

Cautions

- After programming the Pump for use and prior to dispensing the Pump to the patient, always verify through visual inspection that all parameter settings have been set correctly. Incorrect settings may result in unintended results.
- To prevent unauthorised users from changing settings:
 - **Do NOT** distribute a copy of the **Healthcare Professional Instructions for Use of VYAFUSER™ Pump** to a patient or caregiver.
 - **Do NOT** give the Pump to patient/caregiver until you have exited Clinician Settings.

Note: After setting up the Pump for use and before giving it to the patient, the following Delivery System components must be put into the Pump kit box:

- 1 Pump
- 1 Carrying Accessory
- 1 charging system including Battery Charger, AC/Mains Adapter with Charging Cable
- 2 Batteries (one of which may be in the Pump)
- 4 Instructions for Use documents:
 - 1 Patient Instructions for Use of VYAFUSER™ Pump
 - 1 AC/Mains Adapter IFU (Instruction Manual Power Supplies)
 - 1 Battery Charger IFU (RRC-SCC1120-PM Series)
 - 1 Instructions for Use of VYAFUSER™ Pump Carrying Accessory

Do NOT include the Healthcare Professional Instructions for Use of VYAFUSER™ Pump.

Note: If the pump is to be recycled/disposed, do so according to local regulations. Call AbbVie at +420 233 098 111 for additional information.

Contraindication

 The Delivery System should only be used with DUODOPA® SC.

1.5 Pump Components

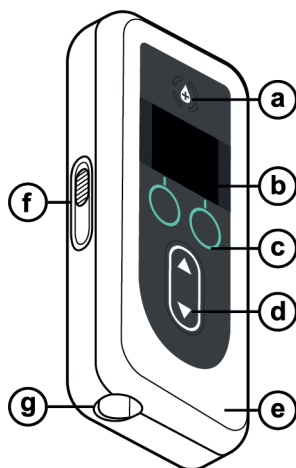

a.	Extra Dose Button	Used to deliver Extra Doses of DUODOPA® SC, if allowed, as determined by the Healthcare Professional.
b.	Display	Contains Pump status information and options for user actions.
c.	Selection Buttons	Used to select between different choices on the Display.
d.	Arrow Keys	Up Arrow: Used to scroll through menu options or increase a value. Down Arrow: Used to scroll through menu options or decrease a value.
e.	Lid	The Pump is a clamshell which opens for inserting and removing the Syringe. This part of the clamshell, with the Display, Buttons, and Arrow Keys, is referred to as the Lid.
f.	Lid Latch	The Lid Latch can be slid to release the Lid closing lock.
g.	Syringe Opening	The portion of the Syringe that connects to the tubing protrudes through this opening.

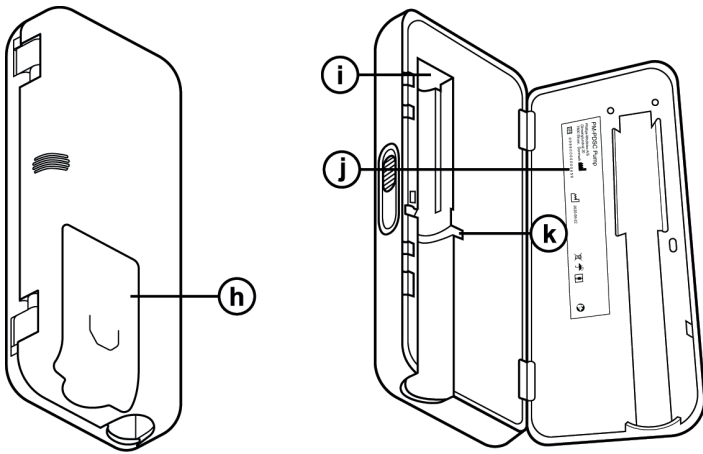

h.	Battery Cover	Slides into place to close the Battery compartment
i.	Syringe Plunger Rod Pusher	Pump mechanism that pushes against the Syringe plunger rod to control the flow of DUODOPA® SC.
j.	Pump Information	Includes model and serial number.
k.	Syringe Flange Grooves	Houses the Syringe flanges and ensures proper alignment of the Syringe when inserted into the Pump.

THIS PAGE IS INTENTIONALLY LEFT BLANK.

2. Initial Setup

2.1 Initial Setup

Before the Pump can be used by the Patient, a PIN (only for HCP access) and Base Continuous Infusion Rate must be entered and confirmed. During this initial setup it is also possible to set High and Low Continuous Infusion Rates as well as Extra Dose and Loading Dose values. The default value for Base is 0.15 mL/h. The default values for the High and Low rates are the same as the confirmed Base rate (High and Low will not be available unless value different to Base is set). The default values for Extra Dose and Loading Dose are 0.0 mL, which means that they are not available, but if values other than 0 are set they will be available.

2.2 Inspect Components and Install Battery

- 1. Remove the Pump and one Battery from the Pump Kit (carton).**
 - a. Inspect the Pump and Battery to ensure there is no damage.
- 2. Ensure you are using the Model RRC1120-PM battery provided with VYAFUSER™ Pump.**
- 3. Set up the Charging System.**
 - a. Remove AC/Mains Adapter, charging station cable, and Battery Charger from Pump kit.
 - b. Connect the charging station cable to both the AC/Mains Adapter and Battery Charger.
 - c. Plug AC/Mains Adapter into wall outlet.
 - d. Ensure red indicator is lit.
 - e. When red indicator is lit, the Battery Charger is ready to charge the Battery.



***AC/Mains Adapter
and Battery Charger***

Please refer to your ***AC/Mains Adapter*** and ***Battery Charger*** Instructions for Use in this section.

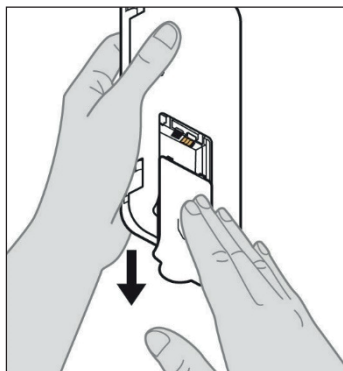

Figure A

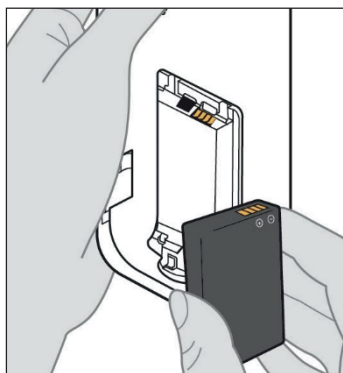

Figure B

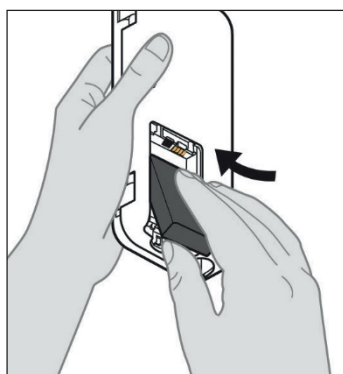

Figure C

4. Charge the battery fully before use.

Note: Before use and before giving batteries to patients, ensure all batteries are fully charged.

Note: The batteries provided in the Pump Kit (carton) are not fully charged by the manufacturer.

5. Remove the Battery Cover from the Pump (see *Figure A*).

6. Insert Battery into the Battery compartment.

- a. Match the metal contacts of the Battery and Battery compartment (see *Figure B*).
- b. With the metal contact end inserted first, slide the Battery into the compartment (see *Figure C*).

Note: You will hear a “click” when the Battery is in place.

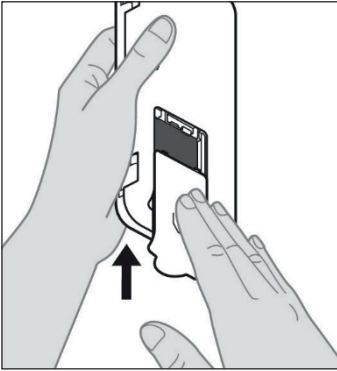
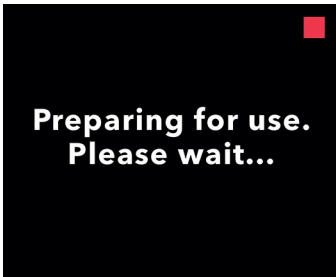
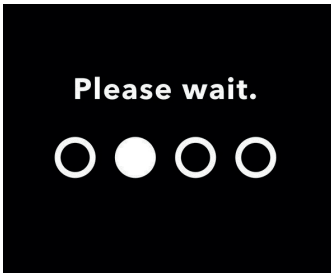

Figure D

7. Slide the Battery Cover onto the Pump (see *Figure D*).



8. After inserting the new battery, the Pump will run power on self tests.



2.3 Set PIN

When setting up the Pump for the first time, you must set a 4-digit PIN that you will need to remember for later use, for example when changing patient values in the future.

Note: Before creating the PIN, make sure that you know all of the dose values you plan to enter for Continuous Dose, Extra Dose, and Loading Dose.

This is important because once you begin setup, after 5 minutes of inactivity, the Pump will automatically exit the configuration attempt. NONE of the values (which includes the PIN), will be saved, and initial setup will need to be started from the beginning. The values will be saved only after you have confirmed the PIN and all dose values, AND after you acknowledged that the initial setup is complete.

If the Pump exits initial setup without your having confirmed all dose values, initial setup will need to be started from the beginning.

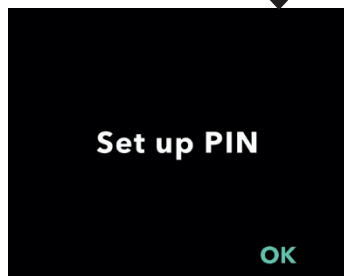
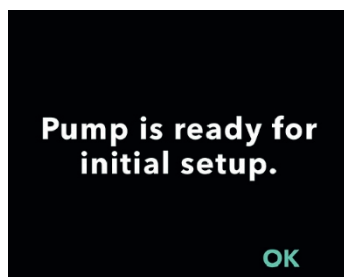

1. Follow the prompts on the Display.

- a. Press OK to advance.
- b. Press OK again to begin setting the PIN.

Note: You will need to remember this PIN to access Clinician Settings in order to change therapy settings, if needed. If you enter a PIN that is not accepted, the screen will display "Invalid PIN" after which you may try again.

Note: The PIN can NOT use 4 repeating digits (e.g., 2222) and can NOT use 4 consecutive digits (e.g., 2345 or 5432).

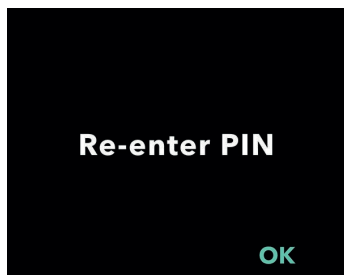
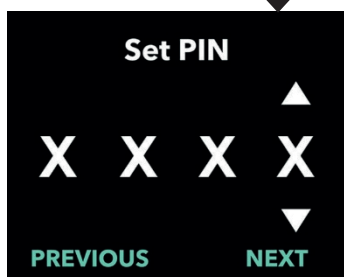
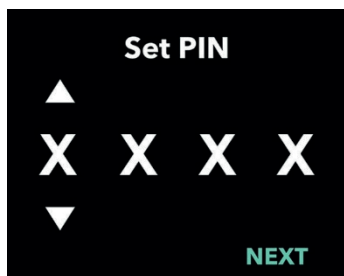

2. Enter a PIN digit.

- Use the Arrow Keys to choose the number.
- Use the NEXT or PREVIOUS buttons to select which digit you wish to change.
- Once the desired PIN is displayed, press NEXT to advance to the next screen.

Note: If the screen displays "Invalid PIN," re-enter the PIN and ensure that the PIN is not repeating 4 digits (e.g., 5555) and that the 4 digits are not in consecutive order (e.g., 5678 or 8765).

3. Press OK to re-enter the PIN.

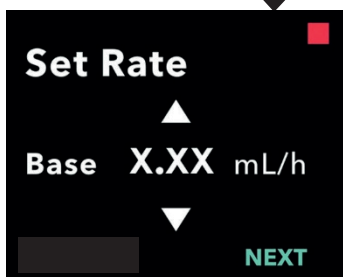
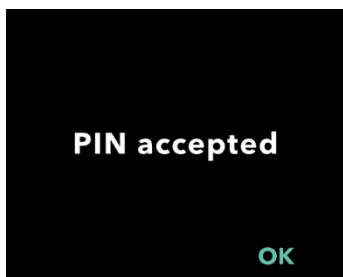
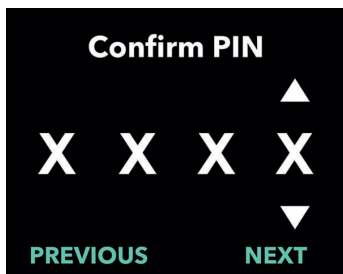

4. Re-enter and confirm the PIN.

- Use the Arrow Keys to choose the number.
- Use the NEXT and PREVIOUS buttons to select which digit you wish to change.
- Once the same PIN has been entered, press NEXT to save the PIN and advance to the next screen.
- After the PIN is saved, press OK to continue. You will next be prompted to enter all of the patient settings.

5. Set Continuous Infusion Base Rate.

- After saving the PIN, the first setting is the continuous dose base rate. See next page to continue.

Note: The up arrow, used to increase values, will not be displayed when the rate cannot be increased. The down arrow, used to decrease values, will not be displayed when the rate cannot be decreased. This occurs when the rate is at the Pump maximum or minimum. It also occurs because the High rate cannot be Less than Base and the Low rate cannot be greater than Base.

2.4 Set Continuous Infusion Rates

Discuss and establish a frequency for changing Syringes with your patient based on the patient's needs. Any time the Continuous Infusion Rate is changed, revisit this schedule with the patient.

Up to 3 different Continuous Infusion Rates (Base, High, Low) can be set to allow the patient to choose up to 3 pre-set Rates throughout the day. Base should be used as the standard Continuous Infusion Rate. High and Low rates are optional alternative rates to the Base Rate. The Pump prevents Low from being higher than Base and prevents Base from being higher than High.

For patients who will not require Continuous Infusion Rate options, the High and/or Low rates can be turned off. To turn off (disable) the High and/or Low Rate, set the High and/or Low Rate to the same value as the Base Rate.

The Pump's Continuous Infusion Rates range from 0.15 mL/h to 1.25 mL/h and can be set in increments of 0.01 mL/h.



1. Set the Base Rate.

- a. Use the Arrow Keys to choose the value.
- b. Press NEXT once Base Rate is set to the correct value.

Note: During first time setup, the displayed rate is the lowest Continuous Infusion Rate that can be set.

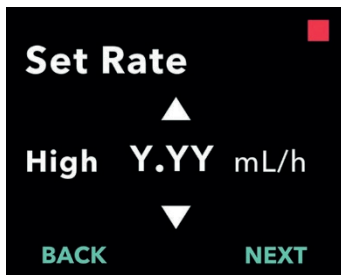

2. Set the High Rate.

- a. Use the Arrow Keys to choose the value.
- b. Press NEXT once the High Rate is set to the correct value.

Note: To disable the High Rate, set the High Rate to the same value as the Base Rate.

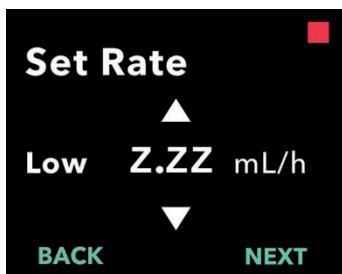

3. Set the Low Rate.

- Use the Arrow Keys to choose the value.
- Press NEXT once the Low Rate is set to the correct value.

Note: To disable the Low Rate, set the Low Rate to the same value as the Base Rate.



4. Confirm Rate values.

- Press CONFIRM.

Note: To change any value, press BACK until you reach the desired screen.

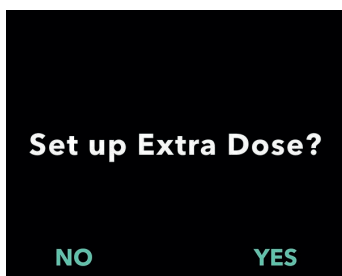

Note: After rate settings are confirmed, the Display will offer the option to set up an Extra Dose.

If you select NO, the Pump will confirm the Extra Dose is not set.

See next page to continue.

2.5 Set Extra Dose

The delivery of an Extra Dose can be enabled. The Extra Dose volume range is 0.1 mL to 0.3 mL, and can be adjusted in increments of 0.05 mL.

Note: If the patient is not going to receive an Extra Dose, when prompted to "Set up Extra Dose?", select "NO". If you accidentally select "YES" and do not want to set an Extra Dose, set the Extra Dose value to 0 mL.

A Lock-out Time interval for Extra Dose deliveries must be configured. The Lock-out Time is the interval from the end of the delivery of the most recent Extra Dose to the next Extra Dose becoming available. During the Extra Dose Lock-out Time, no Extra Dose deliveries can be performed by the Pump. The Lock-out Time prevents the delivery of an unlimited number of Extra Doses. The Lock-out Time range is 1 hour to 24 hours (in 15 minute increments).

Note: If the patient administers a Loading Dose, the start of the Extra Dose lockout time will be re-set.

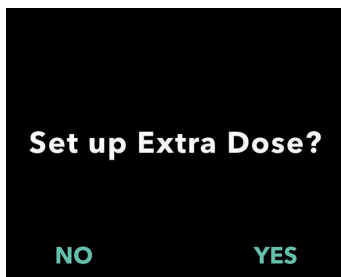

1. Set up Extra Dose.

- Press NO to skip Extra Dose set up and disable Extra Dose.
- Press YES to set up Extra Dose parameters and enable Extra Dose.



2. Set the Extra Dose volume.

- a. Use the Arrow Keys to set the value.
- b. Press NEXT once Extra Dose is set to the desired value.

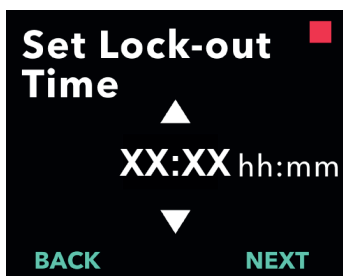

3. Set the Lock-out Time.

- Use the Arrow Keys to set the value.
- Press NEXT once Lock-out Time is set to the desired value.

Note: The minimum Lock-out time is 1 hour.

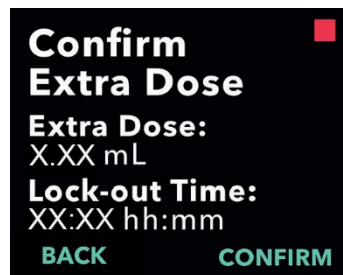

4. Confirm Extra Dose values.

- Press CONFIRM.

Note: To change any value, press BACK until you reach the desired screen.

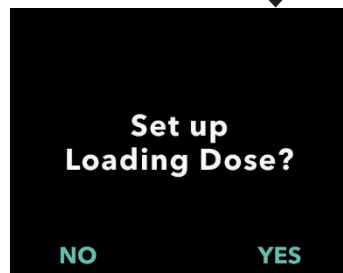

Note: Once Extra Dose and Extra Dose Lock-out Time are confirmed, the Pump will continue to Set Loading Dose.

If you select NO, the Pump will confirm the Loading Dose is not set.

See next page to continue.

2.6 Set Loading Dose

The delivery of a Loading Dose can be enabled. The Loading Dose range is from 0.1 to 3.0 mL and can be adjusted in increments of 0.1 mL.

Note: If the patient is not going to receive a Loading Dose, when prompted to "Set up Loading Dose?", select "NO". If you accidentally select "YES" and do not want to set a Loading Dose, set the Loading Dose value to 0 mL.

A Loading Dose Lock-out Time is the interval from the time the Pump is stopped until the time the Pump is able to deliver a Loading Dose. During the Lock-out Time, no Loading Dose deliveries can be performed by the Pump. The Lock-out Time prevents delivery of a Loading Dose too soon after the last infusion. The Lock-out Time range is 3 hours to 8 hours in increments of 1 hour.

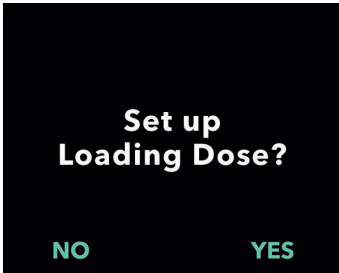

1. Set up Loading Dose.

- Press NO to skip Loading Dose set up and disable Loading Dose.
- Press YES to set up Loading Dose parameters and enable Loading Dose.

Note: By pressing NO to skip setting the Loading Dose, the Pump will display that the Loading Dose was not set. If acknowledged by pressing OK, the Pump displays that the initial setup is complete. At this point the PIN and all dose values will be saved, the Pump automatically exits the Initial Setup, exits Clinician Settings, and will display the Patient Status Screen in stopped mode.



2. Set the Loading Dose value.

- a. Use the Arrow Keys to set the value.
- b. Press NEXT once Loading Dose is set to the correct value.



3. Set the Lock-out Time.

- Use the Arrow Keys to set the time in hours.
- Press NEXT once Lock-out Time is set to the correct value.

Note: The minimum Lock-out time is 3 hours.

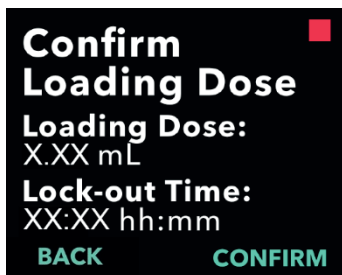

4. Confirm Loading Dose values.

- Press CONFIRM.

Note: To change any value, press BACK until you reach the desired screen.

Note: By pressing CONFIRM, and then acknowledging "Initial setup complete," the Loading Dose will be confirmed AND the PIN and ALL of the dose values (Continuous Rate(s), Extra Dose and Loading Dose) will be saved.

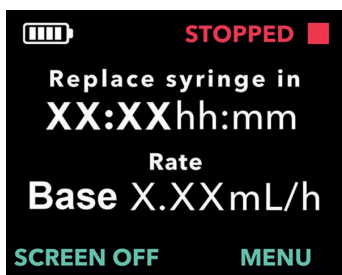
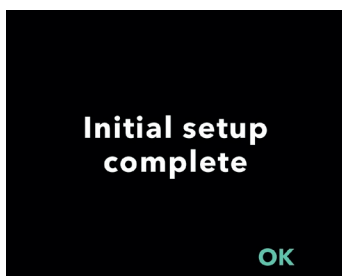

- After pressing OK, the Pump automatically exits Initial Setup and displays the Status Screen in stopped mode.



***Patient Instructions for Use
of VYAFUSER™ Pump***

5. Prepare therapy.

For detailed steps, please refer to the ***Patient Instructions for Use of VYAFUSER™ Pump.***

THIS PAGE IS INTENTIONALLY LEFT BLANK.

3. Change Therapy Settings

3.1 Access Clinician Settings

If changes to patient therapy or other Pump settings are needed after the Initial Setup is complete, you can access the Clinician Settings using the following procedure.

Note: Before entering Clinician Settings, make sure that you know all of the dose values you plan to change. For example, Continuous Dose, Extra Dose, Loading Dose, Lock-out times, PIN, and language (if applicable).

This is important because once you enter Clinician Settings, after 5 minutes of inactivity, the Pump will automatically exit Clinician Settings. Unconfirmed changes will NOT be saved, and Clinician Settings will need to be re-entered. The values will be saved only after you have confirmed the changed setting(s).

The clinician settings will allow you to:

- Set Continuous Infusion Rate Parameters
- Set Extra Dose Parameters (or set to 0 to disable)
- Set Loading Dose Parameters (or set to 0 to disable)
- Change PIN
- Set Pump Language

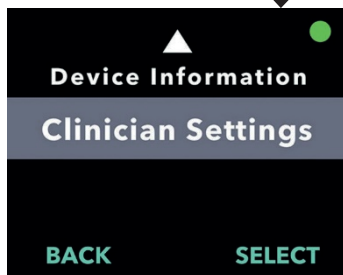
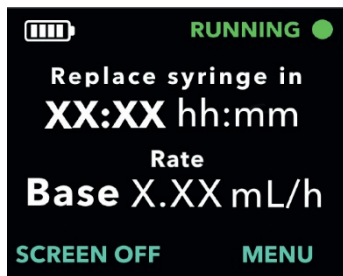

1. Navigate to *Clinician Settings*.

- a. Press MENU to display Pump Menu Options.
- b. Use the Arrow Keys to navigate to *Clinician Settings*.
- c. Press SELECT.

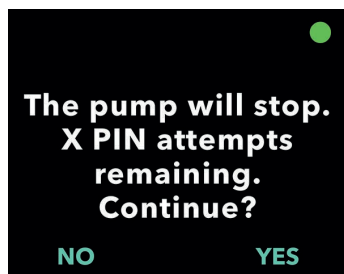

2. If the Pump is running, press YES to confirm Pump stop.

Note: If Pump is not running, the stopped icon (red square) will appear in the upper right corner. The screen will not say "The pump will stop" because it is already stopped.

Note: Pressing NO will return you to the Status Screen, with the Pump still administering therapy.

Note: To access Clinician Settings, the PIN must be entered. The Pump will accept 4 failed attempts for PIN entry and after the 5th failed attempt, it will lock out.

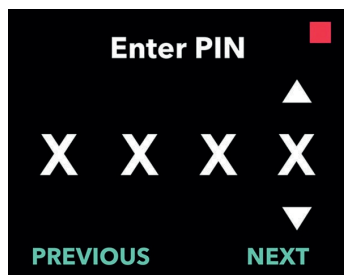

3. Enter the PIN.

- Use the Arrow Keys to choose the number.
- Use the NEXT and PREVIOUS buttons to select each digit.
- Once the correct PIN is displayed, press NEXT to advance to *Clinician Settings* menu.

3.2 PIN Entry Failure

If you entered an incorrect PIN 5 times, the Clinician Settings will be locked.

Note: If the Clinician Settings are locked, the settings cannot be changed but the Pump can still deliver therapy.

If you do not know the PIN, you will need to reset it (see section "Reset PIN (Forgotten PIN)").

Note: The Clinician Settings will remain locked until the PIN reset procedure is followed.

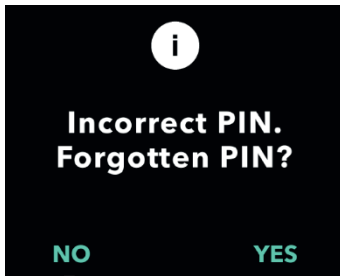

1. Attempt PIN again.

- a. If you know the PIN and entered it incorrectly, press NO so that you can try again.

Note: If you have forgotten the PIN, you will need to reset it.

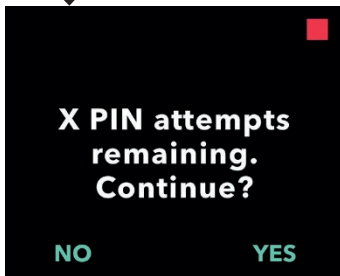

2. To continue, press YES.

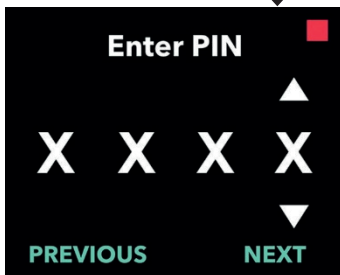

3. Enter the PIN.

- a. Use the Arrow Keys to choose the number.
- b. Use the NEXT and PREVIOUS buttons to select each digit.
- c. Once the correct PIN is displayed, press NEXT to advance to *Clinician Settings* menus.

3.3 PIN Forgotten

If the PIN is forgotten, it can be reset. By choosing to reset the PIN, clinician settings will be locked but the Pump can still deliver therapy.

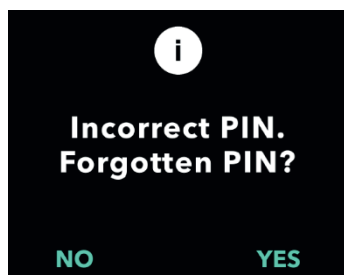

1. If YES, confirm PIN reset is needed.

- a. If you do not know the PIN, you will need to have it reset. If you need to have the PIN reset, Press YES.

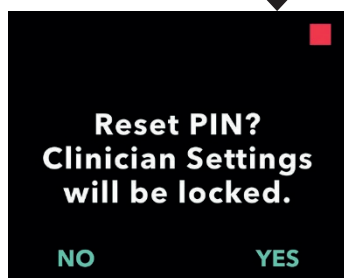

2. Reset PIN.

- a. If you choose to reset the PIN, the Clinician Settings will be locked until the new PIN is entered. With the Clinician Settings locked, changes to the therapy settings cannot be made but the Pump can still run a therapy.

3. If you need to reset the PIN, refer to the section *Reset PIN*.

3.4 Adjust Continuous Infusion Rates

Discuss and establish a frequency for changing Syringes with your patient based on the patient's needs. Any time the Continuous Infusion Rate is changed, revisit this schedule with the patient.

Up to 3 different Continuous Infusion Rates (Base, High, Low) can be set to allow the patient to choose up to 3 pre-set Rates throughout the day. Base should be used as the standard Continuous Infusion Rate. High and Low rates are optional alternative rates to the Base Rate. The Pump prevents Low from being higher than Base and prevents High from being lower than Base.

For patients who will not need different Continuous Infusion Rates, the High and/or Low rates can be turned off. To turn off (disable) the High and/or Low Rate, set the High and/or Low Rate to the same value as the Base Rate.

The Pump's Continuous Infusion Rates ranges from 0.15 mL/h to 1.25 mL/h and can be set in increments of 0.01 mL/h.

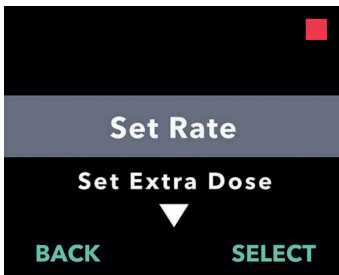

1. Navigate to **Set Rate** in the **Clinician Settings** menu.

- a. Use the Arrow Keys to navigate to **Set Rate**.
- b. Press SELECT to change the rate.

Note: To return to the Status Screen, press BACK.

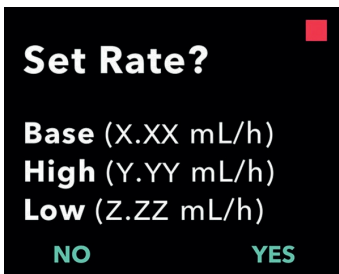

2. Set the Continuous Infusion Rate.

- a. To change a rate, press YES.

Note: The **Set Rate?** screen will display the current set values. If you choose not to change the rate, press NO.



3. Adjust the Base Rate.

- Use the Arrow Keys to choose the value.
- Press NEXT once the Base Rate is adjusted to the correct value.

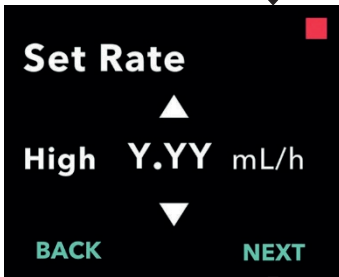

4. Adjust the High Rate.

- Use the Arrow Keys to choose the value.
- Press NEXT once the High Rate is adjusted to the correct value.

Note: To disable the High Rate, set the High Rate to the same value as the Base Rate.

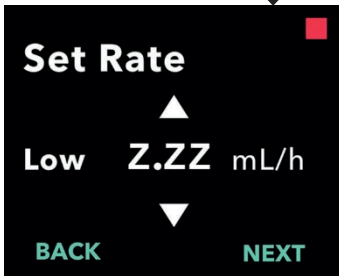

5. Adjust the Low Rate.

- Use the Arrow Keys to choose the value.
- Press NEXT once the Low Rate is adjusted to the correct value.

Note: To disable the Low Rate, set the Low Rate to the same value as the Base Rate.



6. Confirm Rate values.

- a. Press CONFIRM to save the rates.

Note: To change any value, press BACK until you reach the desired screen.

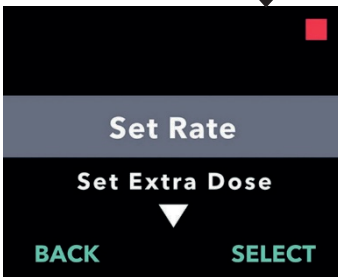

7. To return to the Status screen, press BACK.

- a. To set Extra Dose, scroll to desired option and press SELECT.

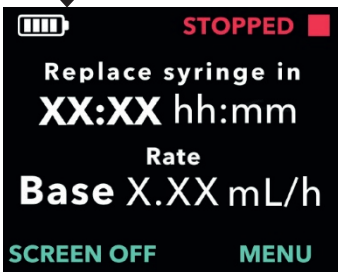

3.5 Adjust Extra Dose

A disabled Extra Dose can be enabled and an enabled Extra Dose can be adjusted by changing the volume or the Lock-out Time. The Extra Dose volume range is 0.1 mL to 0.3 mL, and can be set in increments of 0.05 mL.

Note: Setting the Extra Dose volume to 0.00 disables the Extra Dose delivery feature.

The Extra Dose Lock-out Time is the interval from the end of the delivery of the most recent Extra Dose (or Loading Dose) to the next Extra Dose becoming available. During the Extra Dose Lock-out Time, no Extra Dose deliveries can be performed by the Pump. The Lock-out Time prevents the delivery of too many Extra Doses. The Extra Dose Lock-out Time range is from 1 hour to 24 hours, in 15 minute increments.



1. Navigate to **Set Extra Dose** in the **Clinician Settings** menu.

- Use the Arrow Keys to navigate to **Set Extra Dose**.
- Press SELECT to continue.

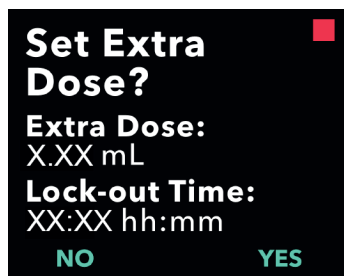

2. **Set Extra Dose.**

- Press YES.

Note: The **Set Extra Dose?** screen will display the current set values.



3. **Adjust the Extra Dose volume.**

- Use the Arrow Keys to choose the value.
- Press NEXT once Extra Dose is adjusted to the desired value.



4. Adjust the Lock-out Time.

- a. Use the Arrow Keys to choose the value.
- b. Press NEXT once Lock-out Time is adjusted to the desired value.

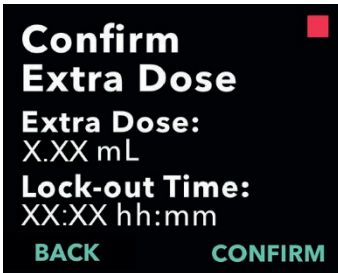

5. Confirm Extra Dose values.

- a. Press CONFIRM to save the Extra Dose settings.

Note: To change any value, press BACK until you reach the desired screen.

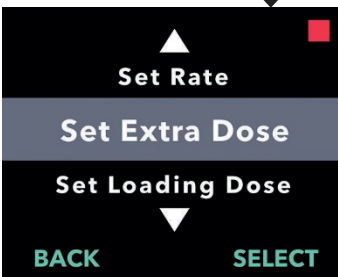

6. Press BACK to return to the Status Screen.

- a. To set Loading Dose or to change the Continuous Rate, scroll to the desired option and press SELECT.



3.6 Disable Extra Dose

Disabling the Extra Dose is done by setting the Extra Dose volume to 0.00.

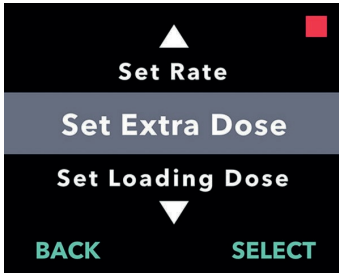

1. Navigate to **Set Extra Dose** in the **Clinician Settings** menu.
 - a. Press SELECT.

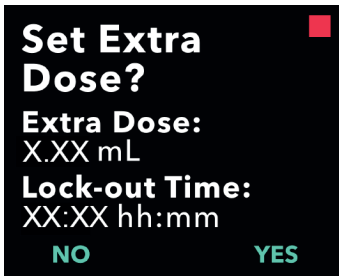

2. **Set Extra Dose.**
 - a. Press YES.

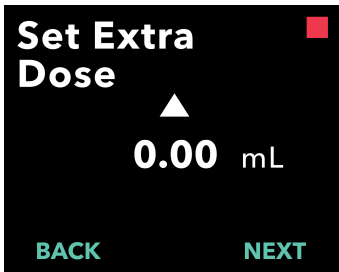

3. **Adjust the Extra Dose value to 0.00.**
 - a. Use the Arrow Keys to choose the value.
 - b. Press NEXT once Extra Dose is adjusted to the correct value.



4. Continue to **Confirm Extra Dose**.

- a. Press NEXT.

Note: The Lock-out Time does not need to be set when disabling Extra Dose.

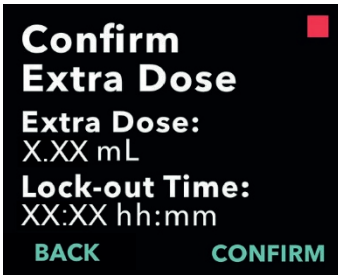

5. Confirm Extra Dose values.

- a. Press CONFIRM.

Note: To change any value, press BACK until you reach the desired screen.



6. To exit Clinician Settings and return to the patient Status Screen, press BACK.

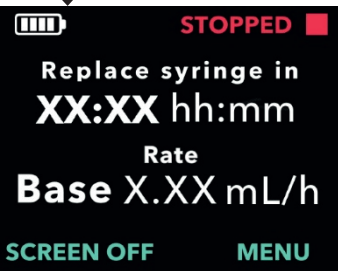

3.7 Adjust Loading Dose

A disabled Loading Dose can be enabled and an enabled Loading Dose can be adjusted by changing the volume or the Lock-out Time. The Loading Dose volume range is 0.1 to 3.0 mL and can be set in increments of 0.1 mL.

Note: Setting the Loading Dose volume to 0.00 disables the Loading Dose delivery feature.

A Loading Dose Lock-out Time is the interval from the time the Pump is stopped until the time the Pump is able to deliver a Loading Dose. During the Lock-out Time, no Loading Dose deliveries can be performed by the Pump. The Lock-out Time prevents delivery of a Loading Dose too soon after the last infusion. The Lock-out Time range is 3 hours to 8 hours in increments of 1 hour.

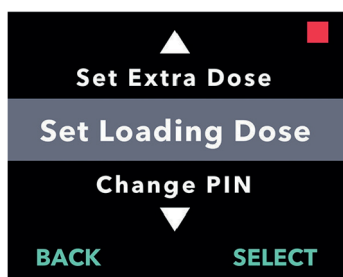

1. Navigate to **Set Loading Dose** in the **Clinician Settings** menu.

a. Press SELECT.

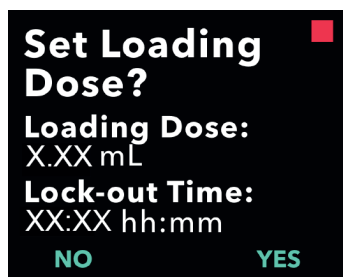

2. **Set Loading Dose.**

a. Press YES.



3. **Adjust the Loading Dose volume.**

a. Use the Arrow Keys to choose the value.

b. Press NEXT once Loading Dose is adjusted to the desired value.



4. Adjust the Lock-out Time.

- Use the Arrow Keys to choose the value.
- Press NEXT once the Lock-out Time is adjusted to the desired value.



5. Confirm Loading Dose values.

- Press CONFIRM to save the Loading Dose values.

Note: To change any value, press BACK until you reach the desired screen.

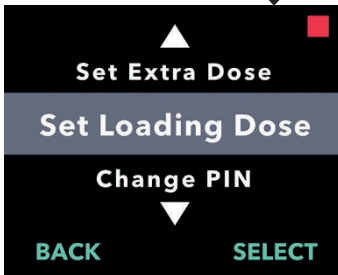

6. Press BACK to return to the Status Screen.



3.8 Disable Loading Dose

Disabling the Loading Dose is done by setting the Loading Dose volume to 0.00.

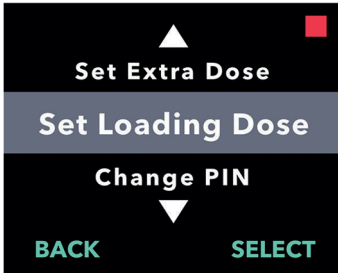

1. Navigate to **Set Loading Dose** in the **Clinician Settings** menu.
 - a. Press SELECT.

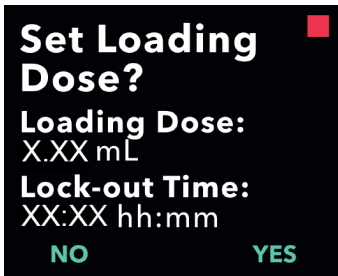

2. Set Loading Dose.
 - a. Press YES.

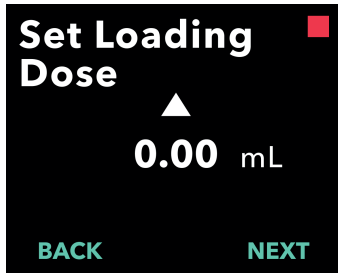

3. Adjust the Loading Dose value to **0.00**.
 - a. Use the Arrow Keys to choose the value.
 - b. Press NEXT once Loading Dose is adjusted to the correct value.



4. Continue to **Confirm Loading Dose**.

- a. Press NEXT.

Note: The Lock-out Time does not need to be set when disabling Loading Dose.

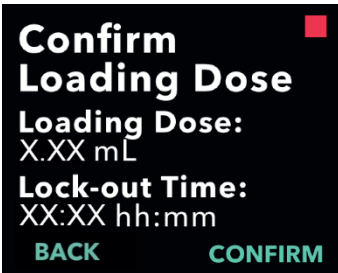

5. Confirm Loading Dose values.

- a. Press CONFIRM.

Note: To change any value, press BACK until you reach the desired screen.

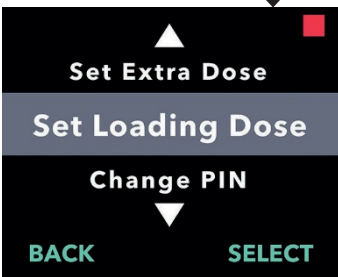

6. Press BACK to return to the Status Screen.

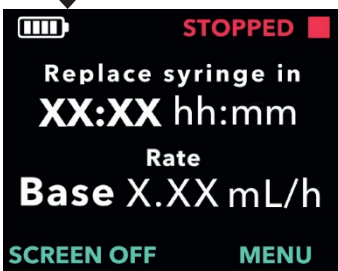

THIS PAGE IS INTENTIONALLY LEFT BLANK.

4. Set Language

If there is more than one language, the Set Language option allows the language to be selected. If the Pump has only one language, the "Set Language" menu option will not be displayed.

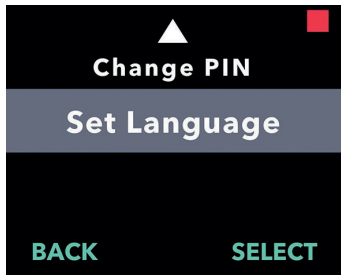

1. Navigate to *Set Language* in the *Clinician Settings* menu.

a. Press SELECT.

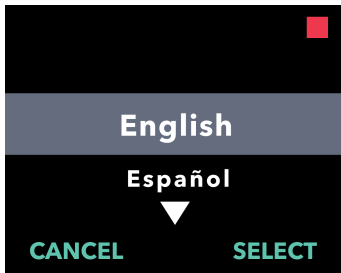

2. Select language.

a. Use the Arrow Keys to choose the language.

b. Press SELECT once the desired language is selected.

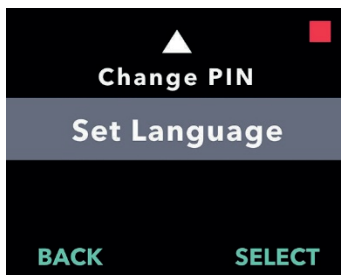

3. Press BACK to return to the Status Screen.

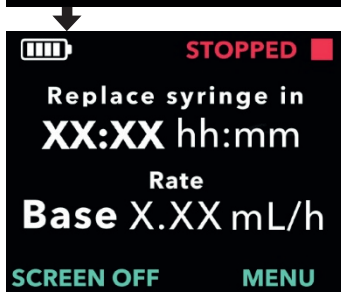

THIS PAGE IS INTENTIONALLY LEFT BLANK.

5. Change PIN

If you need to change your PIN, you can do so within the Clinician Settings menu.

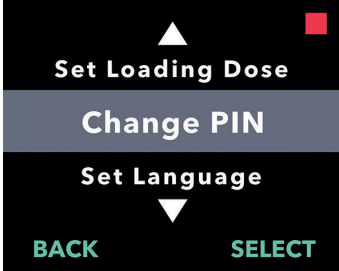

1. Navigate to **Change PIN** in the **Clinician Settings** menu.

- a. Use the Arrow Keys to navigate to **Change PIN**.
- b. Press SELECT to change the PIN.

Note: To return to the Status Screen, press BACK."

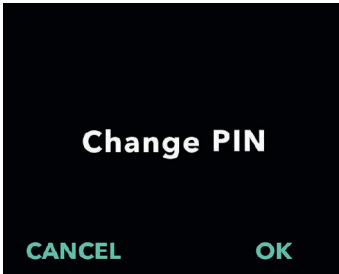

Note: You will need to remember your new PIN to access Clinician Settings in order to change therapy settings, if needed.

Note: The PIN can NOT use the same 4 digits (e.g., 2222) and can NOT use 4 consecutive digits (e.g., 2345 or 5432).

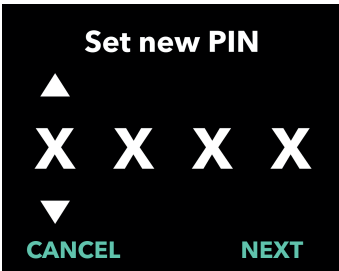

2. Enter the new PIN.

- a. Use the Arrow Keys to choose the number.

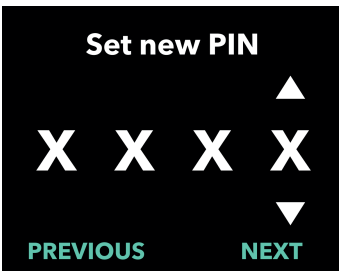

- b. Use the NEXT and PREVIOUS buttons to select each digit.
- c. Once the desired PIN is displayed, press NEXT to advance to the next screen.

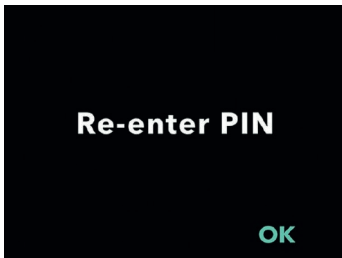

3. Press OK to re-enter and confirm the new PIN.

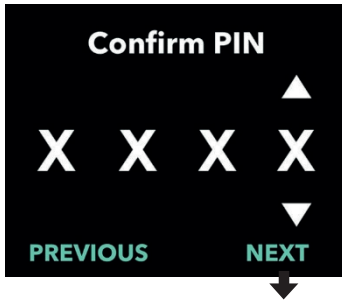

4. Re-Enter the new PIN.
 - a. Use the Arrow Keys to choose the number.
 - b. Use the NEXT and PREVIOUS buttons to select each digit.
 - c. Once the same PIN has been entered, press NEXT to save the PIN and advance to the next screen.

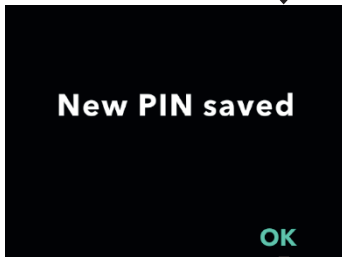

5. Press BACK to return to the Status Screen.



6. Reset PIN (Forgotten PIN)

If the incorrect PIN is entered 5 times or if you forgot the PIN and need to reset it, the Clinician Settings will be locked. You will need to contact AbbVie to reset the PIN.

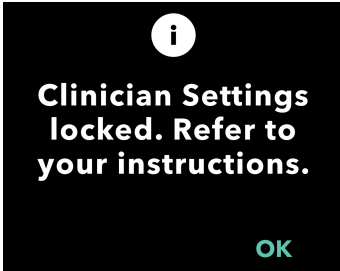

1. Recover access to Clinician Settings.

- a. When Clinician Settings are locked, press OK to proceed.

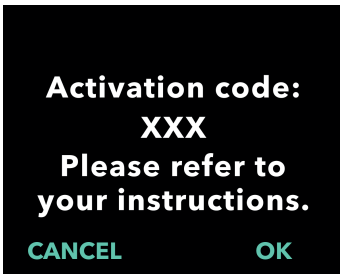

2. Continue to obtain unlock code.

- a. On a piece of paper, write down the 3-digit Activation code that is displayed on the Pump screen. This is the number that must be used to receive the unlock code.

Note: The 3-digit Activation code will not remain on the screen after you press OK.

- b. To obtain the unlock code, call AbbVie at +420 233 098 111. Explain that you need to reset the PIN and give them the 3-digit Activation code that is displayed on the Pump. They in turn will provide you with a 4-digit unlock code.

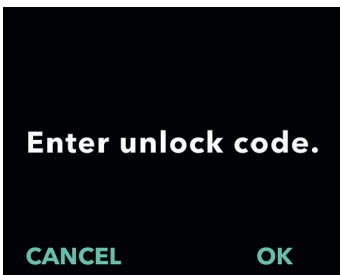

3. Use the Arrow Keys to enter the 4-digit unlock code.

- a. Use the Arrow Keys to enter the 4-digit unlock code.
- b. Use the NEXT and PREVIOUS buttons to select each digit.
- c. After entering the 4-digit unlock code, press NEXT to continue.

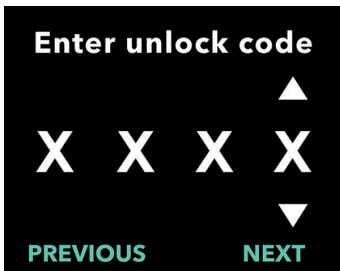

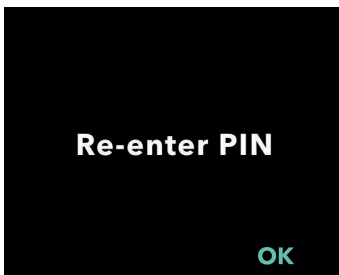
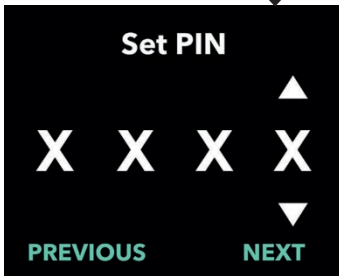
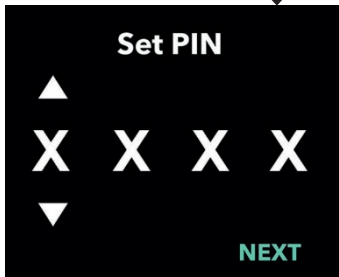
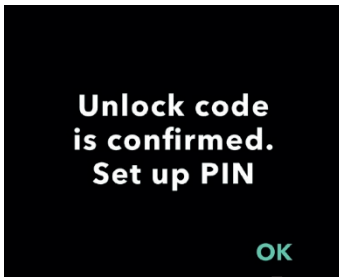

4. Unlock code is confirmed. Set your new PIN

Note: If the correct unlock code has been entered, the Pump will display a message confirming the correct unlock code has been entered.

- a. Press OK to advance to the next screen to set your new PIN.

Note: If an incorrect unlock code was entered, you can try up to 3 times, after which a different 3-digit Activation code will be generated.

5. Set your new PIN.

- a. Use the Arrow Keys to choose the number.
- b. Use the NEXT and PREVIOUS buttons to select each digit.
- c. Once the desired PIN is displayed, press NEXT to advance to the next screen.

Note: If the screen displays "Invalid PIN," re-enter the PIN and ensure that all 4 digits are not the same (e.g., 5555) and that the 4 digits are not in consecutive order (e.g., 5678).

6. Press OK to re-enter and confirm the new PIN.

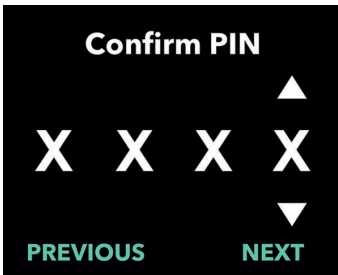

7. Re-enter the new PIN.

- Use the Arrow Keys to choose the number.
- Use the NEXT and PREVIOUS buttons to select each digit.
- Once the same PIN has been entered, press NEXT to save the PIN and advance to the next screen.



8. Press OK and remain in the Clinician Settings menu.

- Scroll through the list to select another setting to change. Press BACK to exit Clinician Settings.

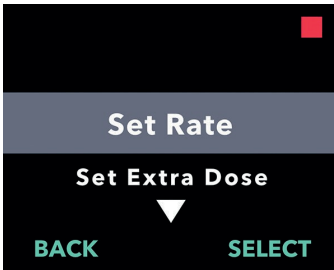

THIS PAGE IS INTENTIONALLY LEFT BLANK.

7. Remove Battery

1. Stop the therapy.

Note: For details, refer to **Patient Instructions for Use of VYAFUSER™ Pump**.

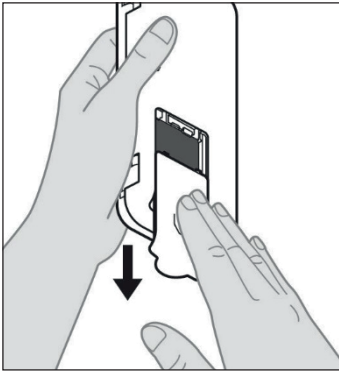

Figure E

2. Remove the Battery

a. Remove the Battery Cover from the Pump (see Figure E).

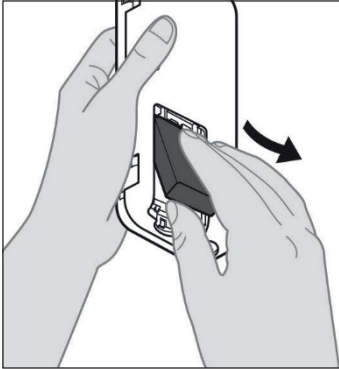
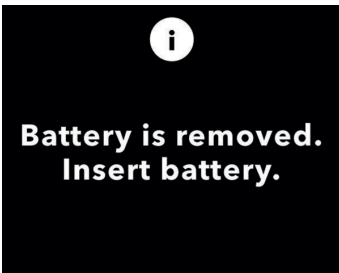

Figure F

b. Remove the Battery (see Figure F).



Note: The Pump Display will remain lit for up to several minutes and will turn off automatically.

Note: The Pump will retain all of the settings after the battery is removed.

THIS PAGE IS INTENTIONALLY LEFT BLANK.

8. Re-packaging for Patient Use

In the event you program the Pump for Patient Use but will need to ship it to the Patient's home, prior to shipping, follow these steps:

- 1. Stop the therapy (for details, refer to *Patient Instructions for Use of VYAFUSER™ Pump*).**
- 2. Remove the Battery from the Pump.**

Note: When the Battery is removed, the Pump displays a message that the Battery is removed. The display remains lit for several minutes. You may re-package while the display is lit because it will turn off automatically.

Note: The Pump will retain all of the settings after the battery is removed.
- 3. Insert the Battery into the small Battery box and then place it on top of the spare Battery in the Battery holder compartment of the Pump kit.**
- 4. Insert the Pump back into the Pump compartment of the Pump kit.**
- 5. Return any other components that were removed during Pump programming to their original compartments in the Pump Kit.**
 - 1 Pump
 - 1 Carrying Accessory
 - 1 charging system including Battery Charger and AC/Mains Adapter with Charging Cable
 - 2 Batteries
 - 4 Instructions for Use documents:
 - 1 Patient Instructions for Use for VYAFUSER™ Pump
 - 1 AC/Mains Adapter IFU (Instruction Manual Power Supplies)
 - 1 Battery Charger IFU (RRC-SCC1120-PM Series)
 - 1 Instructions for Use of VYAFUSER™ Pump Carrying Accessory

6. Close the lid of the box.

Close all of the inner flaps in the kit so when the outer lid is closed, it lays flat.

Note: Do NOT include the ***Healthcare Professional Instructions for Use of VYAFUSER™ Pump.***

9. Subcutaneous Insertion

Proper cannula length selection and placement is critical to ensure intended dosing and administration of DUODOPA® SC. The Healthcare Professional will need to select the cannula size that is long enough to deliver the infusion into the subcutaneous tissue but will not infiltrate the muscle, which can cause pain and/or cause the cannula to bend and potentially result in an occlusion.

To make this selection, the Healthcare Professional should consider different patient characteristics, including the patient's abdominal adipose tissue thickness, abdominal girth, and Body Mass Index. Patients should be trained on proper placement techniques and management of the cannula and infusion set.

THIS PAGE IS INTENTIONALLY LEFT BLANK.

10. Informational Messages

10.1 Informational Messages

The following table (Informational Messages) provides status information and guidance for tasks related to the Clinician Settings.

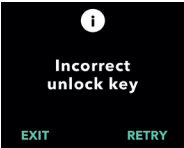
Display	Description	Acoustic Signal	Corrective Action (if applicable)
	Display shows you entered an incorrect PIN and provides a path to re-set it if you forgot it or to try again.	2 Beeps	If you entered a known PIN incorrectly, try again after pressing "NO" (that you did not forget it). If you know you forgot it, respond "YES" and follow the screen prompts carefully. A screen will be displayed with a 3-digit activation code that you will need to use later to obtain an unlock code. Call AbbVie at +420 233 098 111 and tell them the 3-digit Activation code so you can get the unlock code.
	An incorrect unlock code was entered.	2 Beeps	Enter the unlock code again. If an incorrect code is entered 3 times, a new 3-digit activation code will be generated and you will need to use this new code to obtain a new 4-digit unlock code.

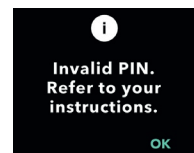
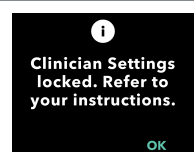
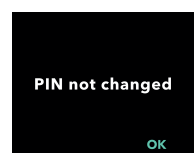
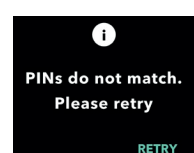
Display	Description	Acoustic Signal	Corrective Action (if applicable)
 <p>Invalid PIN. Refer to your instructions. OK</p>	<p>Display shows you attempted to set a PIN that does not comply with the PIN setup requirements, which include that you cannot use 4 repeating digits (e.g., 3333) and cannot use 4 consecutive digits (e.g., 3456 or 6543).</p>	2 Beeps	<p>Respond "OK" and set a PIN that meets the requirements.</p>
 <p>Clinician Settings locked. Refer to your instructions. OK</p>	<p>The Clinician Settings are locked and cannot be accessed without resetting the PIN. This occurs after 5 incorrect PIN entry attempts.</p>	2 Beeps	<p>After pressing OK to continue, write down the 3-digit Activation Code displayed on the next screen and call AbbVie at +420 233 098 111 to receive the unlock code.</p>
 <p>PIN not changed OK</p>	<p>Information screen when the PIN change procedure is cancelled.</p>	2 Beeps	<p>Press OK to continue</p>
 <p>PINs do not match. Please retry RETRY</p>	<p>When setting up the PIN, the new PIN and the PIN re-entered must be the same.</p>	2 Beeps	<p>Press RETRY and start over by entering the new PIN.</p>

11. Technical Specifications

11.1 Technical Features

Pump Dimensions	170 x 76 x 33 mm (6.7 x 3.0 x 1.3 in)
Pump Weight	285 g (10.0 oz.), including Battery
Battery	3.6 V Li-Ion
Pump Ingress Protection Rating	IP22
Pump Security Lock Levels	Protected Clinician Mode
Permissible Orientations of the Pump	No specific orientation required
Continuous Dose Delivery Flow Rates	Programmable from 0.15 mL/hr to 1.25 mL/hr with 0.01 mL/hr increments
Number of Selectable Flow Rates	Up to 3, based on configuration
Average Flow Rate During Extra Dose and Loading Dose Delivery	5.5 mL/hr
Priming Volume	From 0.15 to 0.6 mL
Extra Dose Volume	Programmable from 0.1 mL to 0.3 mL in 0.05 mL increments
Lock-out Time Interval Between Extra Doses	Programmable from 1 hour to 24 hours in 15 minute increments
Loading Dose Volume	Programmable from 0.1 mL to 3.0 mL in 0.1 mL increments
Lock-out Time Interval Between Loading Doses	Programmable from 3 hours to 8 hours in 1 hour increments
Expected Service Life of the Pump	The Pump is expected to have a service life of 3 years.

Time to Bring System to Operating Temperature	<p>The System is designed to operate at between 41 °F (5 °C) and 104 °F (40 °C). It may, however, be stored between -4 °F (-20 °C) and 140 °F (60 °C).</p> <p>If the system is stored or transported at the maximum or minimum temperatures allowed for storage and transport, it requires 30 minutes in a 20 °C environment to reach operating temperature.</p>
Maximum Infusion Pressure Generated by Pump	200 kPa
Maximum Time for Activation of the Occlusion Alarm	<p><i>Note:</i> Changes in temperature and infusion set length may affect the time to detect an occlusion.</p> <p>The time to detect an occlusion when infusing under the following conditions shall not exceed 5 hours:</p> <ul style="list-style-type: none"> • basal delivery flow rate of 0.15 mL/hr • infusion set length of 60 cm • occlusion at patient end of infusion set • ambient temperature of 68 +/- 4 °F (20 +/- 2 °C) • ambient humidity of 65 +/- 5 % RH <p>The time to detect an occlusion when infusing under the following conditions shall not exceed 2 hours:</p> <ul style="list-style-type: none"> • basal delivery flow rate of 0.70 mL/hr • infusion set length of 60 cm • occlusion at patient end of infusion set • ambient temperature of 68 +/- 4 °F (20 +/- 2 °C) • ambient humidity of 65 +/- 5 % RH

<p>Maximum Volume of Unintended Bolus After Occlusion</p>	<p>The Pump, when pumping at 0.7 mL/hr, has a maximum unintended bolus volume of 0.8 mL under the following conditions:</p> <ul style="list-style-type: none"> • infusion set length of 60 cm • occlusion at patient end of infusion set • ambient temperature of 68 +/- 4 °F (20 +/- 2 °C)
<p>System Operating Conditions</p>	<p>The Pump, Battery Charging System, and Carrying Accessory are designed to maintain all essential performance requirements when operating with a temperature range of +41 °F (5 °C) to +104 °F (40 °C), inclusive, within the humidity range of 15% to 90% non-condensing, inclusive, and within the atmospheric pressure range of 70 kPa to 106 kPa, inclusive.</p>
<p>Pump Kit Storage and Transport Conditions (including the Pump, Battery Charging System, and Carrying Accessory)</p>	<p>-4 °F to 41 °F (-20 °C to 5 °C) with uncontrolled humidity</p> <p>41 °F to 104 °F (5 °C to 40 °C), up to 90% relative humidity non-condensing</p> <p>104 °F to 140 °F (40 °C to 60 °C), up to 15% relative humidity non-condensing</p> <p><i>Note:</i> At atmospheric pressure ranging from 53.3 kPa to 106 kPa, inclusive.</p>
<p>Delivery Accuracy</p>	<ul style="list-style-type: none"> • Valid for environmental operating conditions specified above • Valid for Infusion Sets listed at devices.abbvie.com <p>Continuous Doses:</p> <ul style="list-style-type: none"> • ±10% for continuous dose flow rates <p>Loading Doses:</p> <ul style="list-style-type: none"> • +/- 25 % for delivery volumes up to but not including 1.4 mL • +/- 10 % for delivery volumes equal to or greater than 1.4 mL <p>Extra Doses:</p> <ul style="list-style-type: none"> • +/- 25 %

Maximum Pumping Rate During Priming	The maximum flow rate for the first priming step is 90 mL/hr. The priming volume is limited to 0.6 mL per priming cycle.
Typical Pump Operating Time with a New Fully-Charged Battery	<p>A new fully-charged battery is expected to power the pump for 36 hours until the "battery empty" alarm when pumping at 0.7 mL /hr at 68 °F (20 °C).</p> <p>A new fully-charged battery is expected to power the pump for 32 hours until the "battery empty" alarm when pumping at 1.25 mL /hr at 68 °F (20 °C).</p>

The Pump has the following primary mitigations against under-infusion:

- Required confirmation of all delivery rates and volumes set by the Healthcare Professional.
- Required confirmation of all delivery rates selected by the user.
- Occlusion detection
- Independent circuitry that checks against malfunctioning software or hardware.

The Pump has the following primary mitigations against over-infusion:

- Maximum programmable rates are consistent with expected patient needs.
- Required confirmation of all delivery rates and volumes set by the Healthcare Professional.
- Required confirmation of all delivery rates selected by the user.
- Independent circuitry that checks against malfunctioning software or hardware.

Note: Maximum Volume Infused under Single Fault Conditions:

If the Pump malfunctions in an over-infusion condition at a delivery rate of less than 6.5 mL/hr, the safety circuit will not detect the over-infusion. During this condition, the entire syringe volume (up to 11 mL) would be delivered at that rate.

Description of pump occlusion threshold:

1. Prevention of the pressure in the syringe exceeding 200 kPa.
2. Detecting syringe pressure increase if line is occluded at pressures below 200 kPa.

Sound Pressure Level:

The high priority alarm has a sound pressure level range from 50 dBA to 67 dBA at 1 meter. The low priority alarm has a sound pressure level range from 49 dBA to 62 dBA at 1 meter.

Continuous Dose Delivery Accuracy:

Continuous dose delivery accuracy testing was performed based upon IEC 60601-2-24:2012. Testing was performed with distilled water at room temperature with a 9 mm needle, 60 cm long Neria Guard Infusion Set and with a programmed rate of 0.70 mL/hr: results are shown below.

Mean Flow Error: -0.14%

Start-up graph

Flow rate

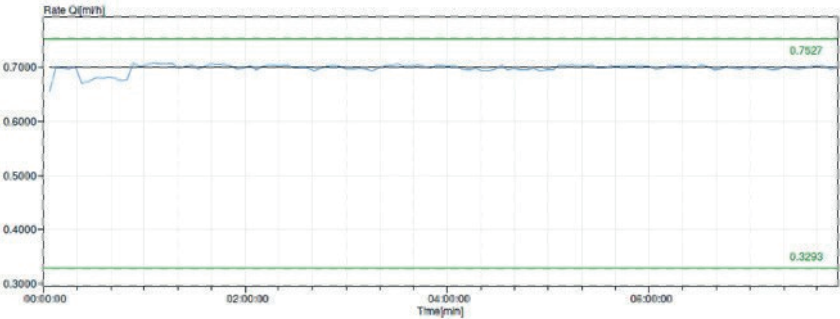

Trumpet Curve from minute 472 - 856

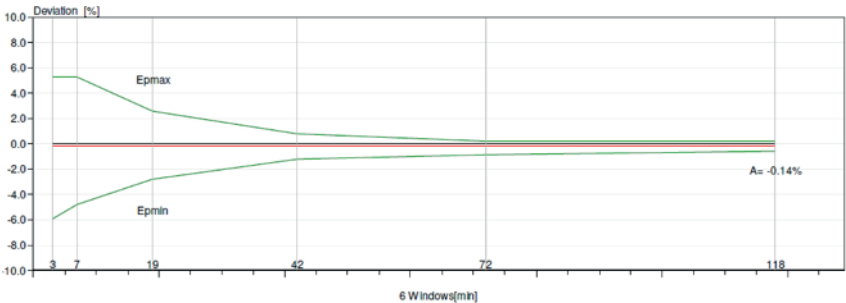











Bolus Delivery Accuracy:





Bolus delivery accuracy data was generated based upon IEC 60601-2-24:2012. Testing was performed with distilled water at room temperature with a 9 mm needle, 60 cm long Neria Guard Infusion Set.





Bolus Dose Volume Target	Number of Successive Bolus Deliveries	Delivered Volume (mL)	Calculated Mean Deviation from Set Value (mL)	Calculated Percentage Deviation from the Set Value (%)
0.1 mL (Minimum bolus volume setting)	25	2.52755	0.02755	Total volume: 1.1 Max negative: 5.65 Max positive: 4.25
3.0 mL (Maximum bolus volume setting)	3	9.23863	0.23863	Total volume: 2.65 Max negative: 4.23 Max positive: 6.39



12. Reference

12.1 Explanation of Symbols

Symbol	Title and Designation Number of Standard Regulation or Guidance	Reference Number	Title/Meaning of Symbol
	EN ISO 7010:2020 ISO 7010: 2019	ISO 7010- W001	General Warning Sign
	EN ISO 15223-1:2021 ISO 15223-1:2021	5.1.1	Manufacturer
	EN ISO 15223-1:2021 ISO 15223-1:2021	5.1.3	Date of Manufacture
	EN ISO 15223-1:2021 ISO 15223-1:2021	5.1.5	Batch Code
	EN ISO 15223-1:2021 ISO 15223-1:2021	5.1.6	Catalog Number
	EN ISO 15223-1:2021 ISO 15223-1:2021	5.1.7	Serial Numbers
	EN ISO 15223-1:2021 ISO 15223-1:2021	5.3.4	Keep Dry
	EN ISO 15223-1:2021 ISO 15223-1:2021	5.3.7	Temperature Limits
	EN ISO 15223-1:2021 ISO 15223-1:2021	5.3.8	Humidity Limits
	EN ISO 15223-1:2021 ISO 15223-1:2021	5.3.9	Atmospheric Pressure Limits
	EN ISO 15223-1:2021 ISO 15223-1:2021	5.4.12	The medical device can be used multiple times by a single patient medical device

Symbol	Title and Designation Number of Standard Regulation or Guidance	Reference Number	Title/Meaning of Symbol
	Regulation (EU) 2017/745	Annex V	CE mark, indicates that this device is in conformity with the applicable requirements set out in (EU) 2017/745 and other applicable directives and regulations.
	EN ISO 15223-1:2021 ISO 15223-1:2021	5.7.7	Medical Device
	1. ASTM F2503-20 2. Testing and Labeling Medical Devices for Safety in the Magnetic Resonance (MR) Environment, FDA Guideline May 20, 2021	1. Figure 9 2. VIII	MR Unsafe The medical device is magnetic resonance unsafe and should be kept away from magnetic resonance environments such as MRI scanner rooms.
	EN 50419:2006	Clause 4.2	WEEE (EU- directive) The product should not be discarded as unsorted waste but must be sent to separate collection facilities for recovery and recycling.

Symbol	Title and Designation Number of Standard Regulation or Guidance	Reference Number	Title/Meaning of Symbol
	EU Directive 94/62/ EC of 20 December 1994 on Packaging and Packaging Waste & EU Commission Decision 97/129/EC	20 is reserved for corrugated fiberboard (PAP- paper)	Recycling
	IATA Dangerous Goods Regulations	Figure 7.1.C	Dangerous Goods
	EN ISO 7010:2020 ISO 7010: 2019	ISO 7010- M002	Refer to instruction manual/booklet
	IEC 60417:2002 DB	IEC 60417- 5333	Type BF Applied Part
IP22	IEC 60529:2001	Clause 4.1 and 4.2	Protected against foreign objects of Ø 12.5mm and greater Protection against vertically falling water drops when ENCLOSURE tilted up to 15°
Rx only	21CFR801.109	(b) (1)	This symbol statement is used to indicate that US Federal law restricts this delivery system from being used or being sold unless it is ordered by a physician.

Symbol	Title and Designation Number of Standard Regulation or Guidance	Reference Number	Title/Meaning of Symbol
	EN ISO 15223-1:2021 ISO 15223-1:2021	5.1.4	Use by date (expiration date)*
 devices.abbvie.com	EN ISO 15223-1:2021 ISO 15223-1:2021	5.4.3	Consult instructions for use or electronic instructions for use

* This symbol does not appear on and does not apply to the pump or carrying accessory labels.

References

EN ISO 15223-1:2021 Medical Devices — Symbols to be used with medical device labels, labeling, and information to be supplied — Part 1: General Requirements

ISO 15223-1:2021 Medical Devices — Symbols to be used with medical device labels, labeling, and information to be supplied — Part 1: General Requirements

EN ISO 7010:2020 Graphical symbols — Safety colours and safety signs — Registered safety signs

ISO 7010:2019 Graphical symbols — Safety colours and safety signs — Registered safety signs

IEC 60529:2001 Degrees of protection provided by enclosure (IP code)







IEC 60417:2002 DB Graphical symbols for use on equipment

Testing and Labeling Medical Devices for Safety in the Magnetic Resonance (MR) Environment, FDA Guideline May 20, 2021

21 CFR 801.109 Code of Federal Regulations Title 21 Volume 8 Sec.801.109 Prescription Devices

ASTM F2503-20 Standard Practice for Marking Medical Devices and Other Items for Safety in the Magnetic Resonance Environment

12.2 Pump Kit Labels

Symbol	Title and Designation Number of Standard Regulation or Guidance	Reference Number	Title/Meaning of Symbol
	N/A	N/A	Instruction Manual
	N/A	N/A	Charging System (mains/ AC adapter and charging station)
	N/A	N/A	Charging System Note: Lift up and to the left to open
	N/A	N/A	Battery
	N/A	N/A	Pump
	N/A	N/A	Carrying Accessory
	N/A	N/A	Carrying Accessory Note: Lift up and to the right to open

**For questions or problems, call AbbVie at
+420 233 098 111.**

Note: Any serious incidents that occur in relation to the device should be reported to the device manufacturer and the competent authority.

THIS PAGE IS INTENTIONALLY LEFT BLANK.